



# Network Video Recorder User Manual



**Model: FN3004H**

**Color: Black**



**Model: FN3004H**

**Color: White**



**Model: FN3104H/FN3109H**

# Table of Contents

Table of Contents.....	1
Security Warning.....	3
Preface.....	4
Important safety instructions.....	5
1 Overview.....	6
1.1 Product Introduction.....	6
1.2 Key Features.....	6
1.3 Relevant Version.....	8
1.4 Icons Description.....	9
1.5 Common Operations.....	9
2 Device.....	11
2.1 FN3104H/FN3109H.....	11
2.1.1 Package Contents.....	11
2.1.2 Installing the HDD.....	11
2.1.3 Device Structure.....	13
2.1.4 IR Remote Control Description(Only FN3104H).....	15
2.1.5 Device Connection.....	16
2.2 FN3004H.....	17
2.2.1 Package Contents.....	17
2.2.2 Device Structure.....	18
2.2.3 Device Connection.....	19
2.3 USB Mouse Operation.....	20
3 GUI.....	22
3.1 Login.....	22
3.2 Setup Wizard.....	22
3.3 Shortcut Menu.....	22
3.4 Menu.....	25

3.4.1 Adding Devices.....	26
3.4.2 Playback.....	30
3.4.3 Backup.....	32
3.4.4 Device Information.....	33
3.4.5 Settings.....	36
3.4.6 System.....	54
4 Web.....	59
4.1 Instructions before Login.....	59
4.2 Login.....	59
4.3 Live Video.....	62
4.4 Parameter Configuration.....	65
4.4.1 Local Settings.....	66
4.4.2 Device Management.....	75
4.4.3 Service Configuration.....	78
4.4.4 User Management.....	90
4.4.5 System Management.....	91
4.5 Playback.....	94
5 Appendix.....	96
5.1 HDD Capacity Calculation.....	96
5.2 Common operations.....	97
5.3 Specifications.....	102
5.4 List of Third-party list.....	107
5.5 FAQ.....	108
5.6 Glossary.....	110
5.7 CE & FCC.....	111
5.8 WARRANTY.....	112
5.9 Obtaining Technical Support.....	115

## Security Warning

---

Foscam cameras and NVRs require good security practices to safeguard your privacy. You should regularly change your camera or NVR password which is 8-10 numbers, letters, symbols combination.

You should update your camera or NVR regularly. Make sure your camera or NVR has the latest firmware installed for your specific model and better experience.

# Preface

---

Welcome to use our product, Network Video Recorder. This document mainly focuses on the installation and configuration of NVR LAN application system. With high performance video, user-friendly GUI, and practical industrial designs. This series NVR is suitable for civil applications such as homes, stores, internet cafes, and small businesses in addition to mainstream security and surveillance applications.

## Model

This manual is applicable to the models listed in the following information.

- NVR FN3104H
- NVR FN3004H
- NVR FN3109H

## Default Settings

The NVR default administrator&password is admin&(blank).

## Declaration

- The feature of product on this manual is just for reference. Please prevail in physical product.
- The manual provides multiple product models for reference. The specific operations are not listed one by one. Please follow the operations depending on the actual product.
- Because the actual environment may be discrepant, the actual values of some data may be different from the values provided in the manual. If there are any question or dispute, the final interpretation of FOSCAM prevails.
- If you do not follow the manual during operation, you will bear any loss caused thereof.

# Important safety instructions

---

This chapter describes how to use the product properly so as to prevent danger and property loss. Be sure to follow the security instructions when operating this product.

## Installation Environment

- Ensure device is installed in the well-ventilated, dust-free environment.
- It is recommended to use a voltage stabilizer for supply of power. If the power supply was unmatched, the device might work abnormally or stop working.
- Check that the voltage of the extra power supply is the same with the NVR's requirement, and the ground connection is working properly.
- The distance between the NVR and other device or wall should be more than 6cm away to facilitate heat dissipation.

## Precautions

- Please keep the device horizontally and avoid inclination or inversion.
- Don't touch the power switch with wet hand or damp items to avoid shock.
- Do not splash liquid or metal filing on the NVR To avoid short-circuit fault or blaze.
- The NVR does not contain any storage device. Please install a hard disk or connect to storage device firstly. Otherwise, you cannot perform operations such as recording and playback.
- Please press power button to shut down the NVR instead cutting off the power directly to avoid to damaged the storage device.
- Do not take the device apart when it is operating(or connecting to power).
- Ensure power cable corresponds to the model of the NVR which produced by Foscam.

# 1 Overview

---

## 1.1 Product Introduction

The series of product series is a Network Video Recorder. This advanced product series receives a high quality video stream that is transmitted digitally by the IP Camera (IPC). The product can perform live video preview, recording, playback, remote access, and backup simultaneously.

## 1.2 Key Features

### Network Monitoring

You can access the NVR system remotely through the browser on a PC or access the NVR system locally by using the display or monitor.

### Multi-screen Preview

Multi-screen preview indicates that several pages are displayed on the screen of the monitor based on the same scale.

### Recording

The NVR supports recording and storing video files on a Hard Disk Drive(HDD). Stored videos files can be queried or played back through Web or local GUI.

Recording can be classified into schedule recording, manual recording, and alarm recording from low priority to high priority. If recording of any two types is enabled at the same time, only the recording of a higher priority takes effect.

- Schedule Recording

You can select the scheduled time segment to enable or disable recording.

- Manual Recording

You can manual enable recording in the corresponding channel.

- Alarm Recording

Alarm recording is classified into I/O alarm recording and motion detection recording.

- I/O Alarm Recording(FN3004H does not supports this function)

After the external alarm function is enabled and the linkage recording channel is selected, I/O alarm recording is enabled when an external alarm is triggered in the trigger time segment.

- Motion Detection Recording

After the motion detection function is enabled and recording is selected, motion detection recording is enabled when motion detection is triggered in the detection time segment and detection area.



**Note**

When NVR system time and IPC time are different, the NVR recording will be based on the NVR system time.

## Playback

You can play back video files stored in the HDD. Recording includes schedule recording, manual recording, and alarm recording. Single-screen playback and four-screen synchronous playback are supported. When display mode is 1080P, it only supports the single-screen playback.

## Alarm

Alarms include I/O alarms and motion detection alarms.

- I/O Alarm (FN3004H does not support this function)

External alarm input devices are connected through the alarm input interface and external alarm output devices are connected through the alarm output interface. After the devices are connected successfully, you can configure information about the external alarm devices. When an alarm is triggered in the preset time segment, the NVR system transmits the alarm information to an external alarm output device, which makes corresponding response. The NVR system can also enable I/O alarm recording, send pictures to your mailbox and the buzzer of the NVR will sound.

- Motion Detection Alarm

You can configure motion detection information about the corresponding channel in the NVR system. When an object moves in the detection time segment and detection area, an alarm is triggered, the NVR system enables motion detection recording, and the alarm output device outputs the alarm (Except FN3004H), sends pictures to your mailbox, and uploads pictures to your FTP server.

## IPC Management



You can search for IPC devices in the LAN through the NVR and add IPC devices to the NVR channel. Through the NVR, you can also manage IPC devices.

## HDD Management

When the HDD becomes exceptional (for example, HDD Loss, HDD Full, and HDD Error), the NVR buzzer sounds an alarm.

When the HDD is full, you can select the cycle cover the earliest recording or stop recording.

## Backup

You can query video files stored by the NVR in the HDD and can back up the files through a USB interface and save the files to a mobile storage device.

## Other Functions

- Support the logging function.
- Support local GUI output and perform shortcut operations through the mouse.
- The NVR may also be controlled with the included IR remote control.(Only FN3104H)
- Three roles can access the NVR, which are respectively visitor, operator, and administrator. The rights of the three roles vary from low to high.

## 1.3 Relevant Version

Name	Recommended Configuration
HDD	You are recommended to equip a 7200 rpm or higher HDD.
Monitor	You are recommended to equip a 16:9 monitor with the resolution higher than 1280*720.
IPC	You are recommended to equip Foscam IPC or IPC supporting ONVIF protocol.
Network	10/100M Ethernet or above.
Browser	This product supports 32-bit IE8 or later versions and does not support 64-bit IE browsers. It also supports Apple Safari and Mozilla Firefox browsers.

## 1.4 Icons Description

- In the live view mode, there are icons at the right top of the full screen.



: The HDD is full, and the recording has been stopped.



: A HDD is not inserted into the NVR or the HDD connected to the NVR is abnormal.

- In the live view mode, there are icons at the right bottom of the screen for each channel,



: NVR is recording for the IPC.



: The alarm of the IPC is triggered.

- The icon  at the right top of the windows: Exit current menu to upper level menu.

## 1.5 Common Operations

### Starting Up the NVR

Turn on the power switch on the rear panel(Except FN3004H). The Power indicator LED should turn green indicating that the device begins to start up.



#### Note

If the power LED indicator on the front panel is off, please check if the power supply is plugged into an electrical outlet and the power switch is turned on;

### Shutting Down the NVR

There are two proper ways to shut down the NVR. To shut down the NVR:

- Shutting down the NVR by the IR Remote Control(Only FN3104H).

Press and hold the POWER button for 3 seconds by the IR Remote Control, and the device will enter power-off process.

- There are two proper ways to shut down the NVR in the GUI interface.

- After login, right-click the mouse, you can click **Shutdown** in the shortcut menu.

- Choose "Menu > System" in the Menu interface, then click **Shutdown** in the System interface.

Then turn off the power switch on the rear panel, the power LED indicator on the front panel turns off.



### Note

Please try to avoid shutting down the unit by turning off the power switch on the rear panel (especially during recording).

## Reset

You can reset the NVR device to restore the factory settings. You can choose any one of the following methods operate.

- Reset button: Press and hold it for 3 seconds to reset all parameters to factory defaults on the bottom of the NVR.
- Local GUI: Choose "Menu > System" in the Menu interface, then click **Factory Reset** in the System interface.
- Web GUI: Choose " (Parameter Configuration) > System Management > Factory Reset". The **Factory Reset** page is displayed.

# 2 Device

## 2.1 FN3104H/FN3109H

### 2.1.1 Package Contents

When you receive the NVR, please open the box and check whether there is any visible damage to the NVR appearance.

Then, please verify that all contents received are complete according to the package contents listed below.

At last, please open the machine crust and check the data wire in the front panel, power wire, the connection between the power and the main board.

● NVR	● CD
● IR Remote Control(Only FN3104H)	● Battery(Only FN3104H)
● DC Power Adapter	● Warranty Card
● Ethernet Cable	● Screw Pack
● USB Mouse	● Antistatic Gloves
● Data Wire and Power Wire of the HDD	● Quick Installation Guide

The package contents list does not contain HDD and IPC for FN3104H.

- It is highly recommended that HDD should be used with Seagate and Westeam Digital and over 7200 RPM. But Do not buy a HDD with automatic sleep function, so as to maintain reliable and stable running of the disks.
- It is highly recommended to use FOSCAM IPC, or the other IPC which supports ONVIF protocol.

### 2.1.2 Installing the HDD

For the first use, please install the HDD.



## WARNING

- Before installing a hard disk drive (HDD), please make sure the power is disconnected from the NVR.
  - Find the ESD gloves from the package of the NVR and wear the gloves.
1. Remove the cover from the NVR by unfastening the screws on the rear and side.



2. Connect one end of the data cable and power cable to the motherboard of NVR and the other end to the HDD.



3. Place the HDD on the bottom of the device using the provided screws and then fasten the screws on the bottom to fix the HDD.

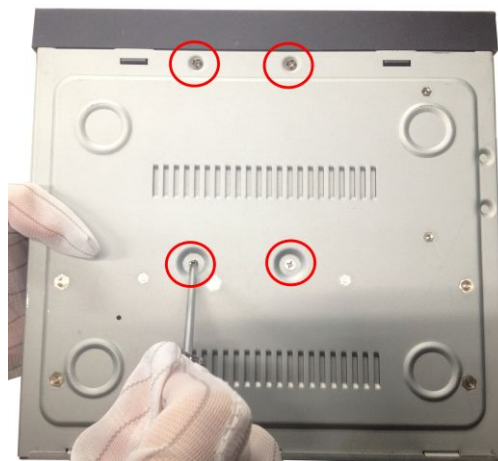

4. Re-install the cover of the NVR and fasten screws.



## 2.1.3 Device Structure



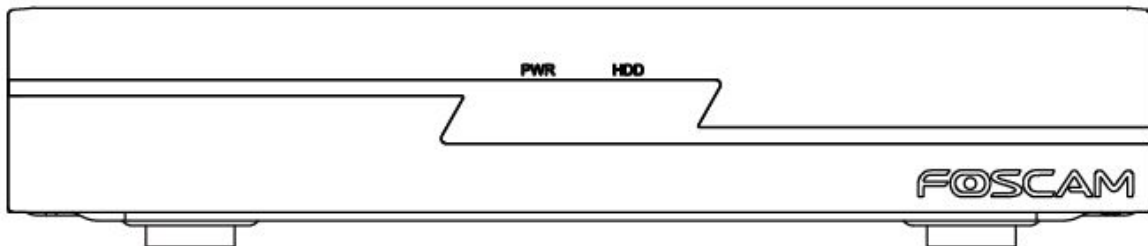



### Front Panel

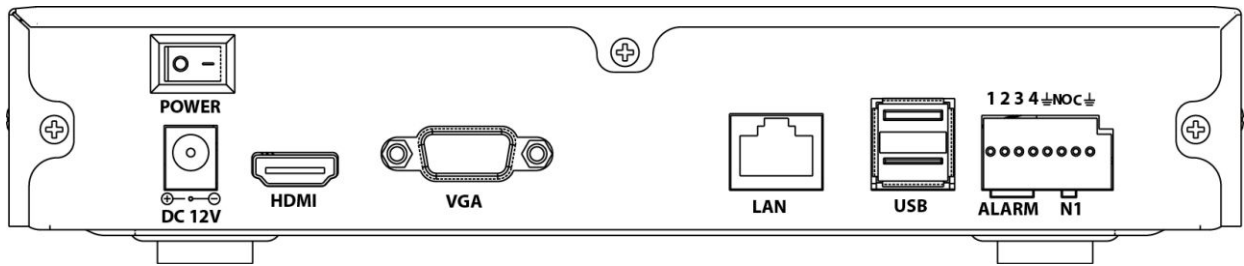

Icon	Name	Description
PWR	POWER Status Indicators	The Power LED on the front panel will light in green after complete the wiring.
HDD	HDD Status Indicators	<p>The red LED is on: The HDD is not installed or cannot be detected.</p> <p>Blinks green: The HDD is writing, the NVR is recording.</p> <p>The green LED is on: The HDD is in the normal status and the NVR does not record.</p>

## Rear Panel



Icon	Name	Description
 POWER	Power Switch	Switch for turning on/off the device.
 DC 12V	Power Supply	12VDC power supply.
 HDMI	HDMI	HDMI video output connector.
 VGA	VGA	VGA video output connector. Display local video output and menu.
 LAN	LAN Interface	Connector for LAN.
 USB	USB Interfaces	Universal Serial Bus (USB) ports for additional devices such as USB mouse and USB Storage device.
<b>1 2 3 4</b>	ALARM IN Interfaces	Connector for alarm input. The interface sequence number matches the channel sequence number, that is, alarm input interface 1 matches channel 1.  When an external power supply is used to power the alarm input device, the alarm input device needs to share the ground with the NVR.
	GND	Ground terminal for alarm input.

<p><b>NOC</b></p>	<p>ALARM out Interfaces</p>	<p>Connector for alarm output. Output alarm signal to the external alarm device. The external alarm device needs a power supply.</p> <p>NO: alarm output end that is always on.</p> <p>C: common alarm output end.</p>
-------------------	-----------------------------	--

### 2.1.4 IR Remote Control Description(Only FN3104H)

The NVR may also be controlled with the included IR remote control.

Note: Make sure you have installed batteries properly in the remote control. And you have to aim the remote control at the IR receiver in the middle position of the front panel.

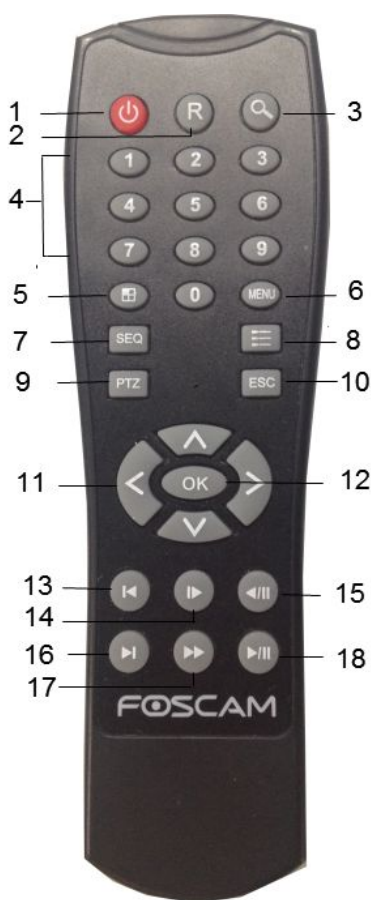

No.	Name	Description
1	Power	Power on/off the device.
2	Recording	Manual Start/Stop recording in the Live view Interface. It is used with direction keys.
3	Playback	Enter the Playback interface, it is used with direction keys.
4	NO. (0-9)	Inputting numbers and characters in editable box, or channel switch.
5	Switch	Switch from single screen and multi-screen in preview mode.
6	MENU	Enter the shortcut menu of setting interface. It is used with direction keys.
7	SEQ	Enable or Disable channel touring according to the touring settings; Press the ESC button to stop.
8	Management	Enter the IPC Management interface, it is used with direction keys.



9	PTZ	Enter the PTZ control interface, it is used with direction keys.
10	ESC	Return or exit operations.
11	Direction	The up, down, left, and right keys can be used with other keys.
12	OK	Press to confirm in menu mode.
13	Previous	Play the previous video file.
14	Frame Forward	View the image of each frame.
15	Rewind key	Select the rewind speed. This key needs to be used with the Play/Pause key.
16	Next key	Play the next video file.
17	Fast forward key	Multiple fast forward speeds and normal playback.
18	Play/Pause	During pause, press the key to play. During play, press the key to pause.

## 2.1.5 Device Connection

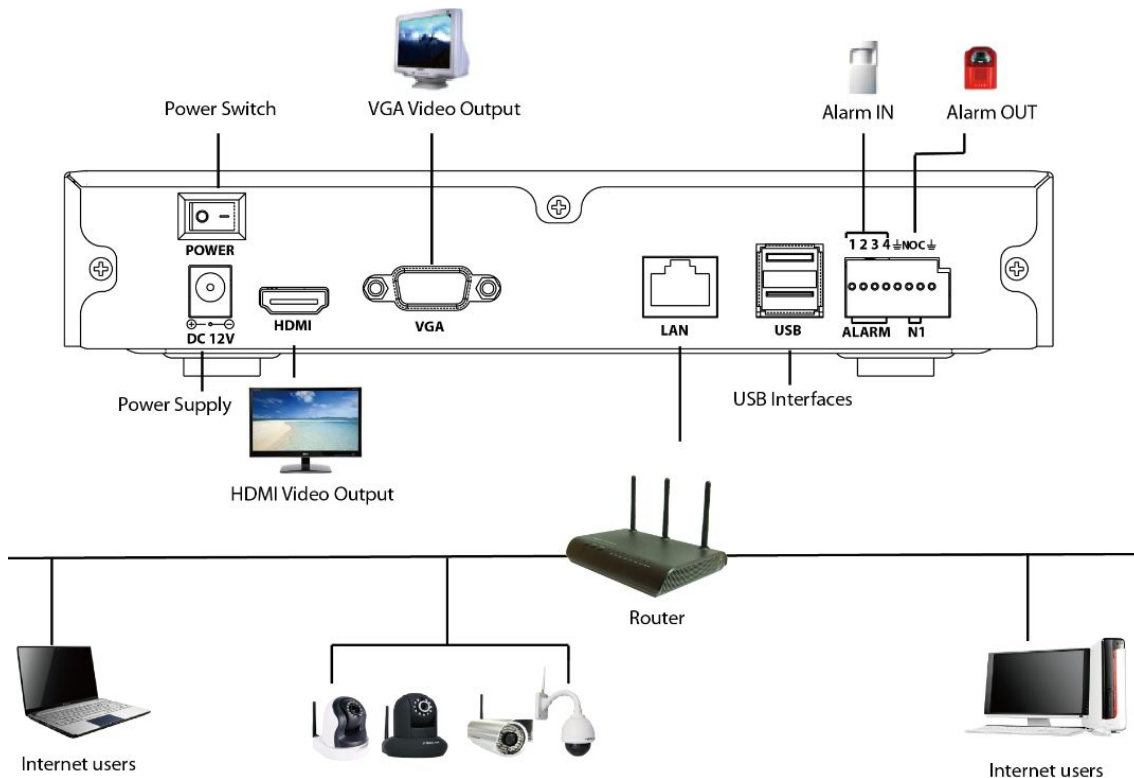

## Connect to the Power Supply

You should first make sure that the AC voltage connected with the NVR power adapter matches with the requirements. And then connect the power adapter to power input interface of NVR, the power indicator on the front panel will light on, indicating the power is connected right.



### Note

Please use the power adapter included in the package to avoid any damage to the equipment.

## Network Access

During the network connection, you should provide sufficient bandwidth to ensure the fluency and clarity of the images transmitted over the network.

## Connect to the Alarm Input and Output Devices

The alarm input/output device should be connect the Alarm IN /Alarm OUT interface of NVR.

## Connect to the Video Output Device

Connect the VGA Monitor to VGA interface of NVR, or Connect the HDMI Monitor to HDMI interface of NVR.

## Connect to the Mouse

Plug USB mouse into one of the USB interfaces of the NVR.

## Connect to the Storage device

Plug USB Storage device into one of the USB interfaces of the NVR.

# 2.2 FN3004H

## 2.2.1 Package Contents

When you receive the NVR, please open the box and check whether there is any visible

damage to the NVR appearance.

Then, please verify that all contents received are complete according to the package contents listed below.

At last, please open the machine crust and check the data wire in the front panel, power wire, the connection between the power and the main board.

• NVR	• CD
• DC Power Adapter	• Quick Installation Guide
• Warranty Card	

The package contents list does not contain a mobile hard disk, IPC and mouse for FN3004H.

- It is highly recommended that the Mobile Hard Disk should be used with Seagate and Westeam Digital and over 5400 RPM for FN3004H.
- It is highly recommended to use a third-party brands mouse whose frequencies should be 2.4GHZ or 5GHZ.
- It is highly recommended to use FOSCAM IPC, or the other IPC which supports ONVIF protocol.

## 2.2.2 Device Structure

### Side Panel

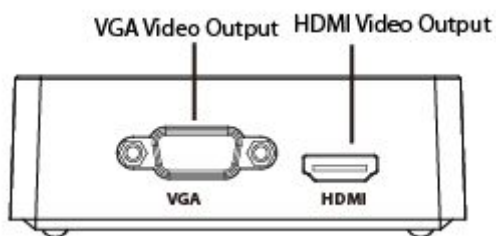



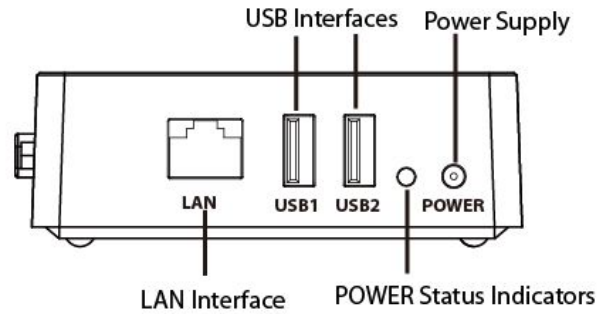

Icon	Name	Description
	HDMI	HDMI video output connector.

 <p>VGA</p>	<p>VGA</p>	<p>VGA video output connector. Display local video output and menu.</p>
--	------------	---

## Rear Panel



Icon	Name	Description
 <p>LAN</p>	<p>LAN Interface</p>	<p>Connector for LAN.</p>
 <p>USB1 USB2</p>	<p>USB Interfaces</p>	<p>Universal Serial Bus (USB) ports for additional devices such as USB mouse and USB Storage device.</p>
	<p>POWER Status Indicators</p>	<p>The Power LED on the front panel will light in green after complete the wiring.</p>
	<p>Power Supply</p>	<p>5VDC power supply.</p>

## 2.2.3 Device Connection

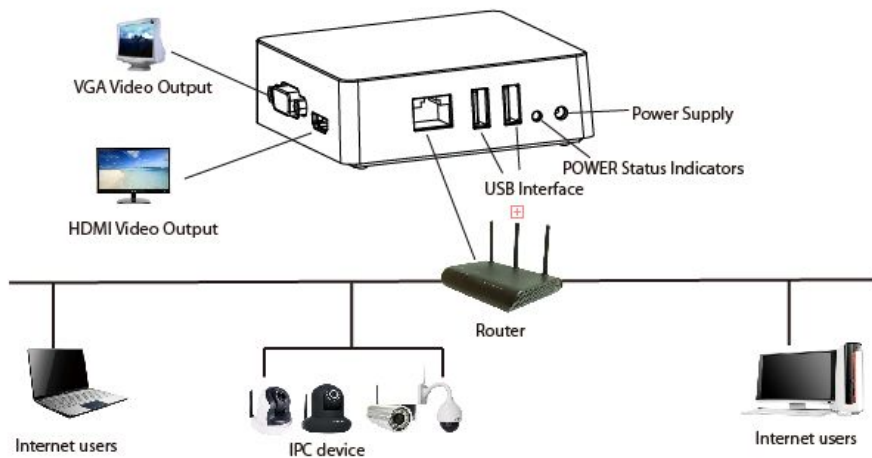

## Connect to the Power Supply

You should first make sure that the AC voltage connected with the NVR power adapter matches with the requirements. And then connect the power adapter to power input interface of NVR, the power status indicators on the rear panel will light in green, which means that the power supply is properly connected.



### Note

Please use the NVR power adapter provided in the package.

## Network Access

During the network connection, you should provide sufficient bandwidth to ensure the fluency and clarity of the images transmitted over the network.

## Connect to the Video Output Device

Connect the VGA Monitor to VGA interface of NVR, or Connect the HDMI Monitor to HDMI interface of NVR.

## Connect to the Mouse

Plug USB mouse into one of the USB interfaces of the NVR.

## Connect to the Storage device

Plug USB Storage device into one of the USB interfaces of the NVR.

## 2.3 USB Mouse Operation

Plug USB mouse into one of the USB interfaces on the rear panel of the NVR.

The mouse should automatically be detected.

The operation of the mouse:

Name	Action	Description
Left-Click	Single-Click	Menu or window: select and enter.
	Double-Click	Preview mode or Playback mode: Switch between single-screen and multi-screen.

	Click and Drag	Time or Area box: Select the time or zone range. Time bar: Drag time bar.
Right-Click	Single-Click	Live view: Show menu. Menu: Exit current menu to upper level menu.

**Note**

The Single-Click mentioned in this article is refer to the left mouse click.

You can visit the local NVR device via the display or monitor, and view or manage NVR system.

NVR device is connected to the network, mouse, and mobile storage devices have been successfully installed. Make sure the video output device is connected successfully.

## 3.1 Login

For the operation, please refer to the Quick Installation Guide.

## 3.2 Setup Wizard

By default, the Setup Wizard starts once the NVR has loaded, as shown in Figure below. The Setup Wizard can walk you through some important settings of the NVR. If you don't want to use the Setup Wizard at that moment, right click the mouse to quit.

For the operation, please refer to the Quick Installation Guide.

## 3.3 Shortcut Menu

After login, right-click the mouse, you will enter the shortcut menu.



## One-Screen/Four-Screen/Nine-Screen

Switch between different channels video.

Note: Only FN3109H supports Nine-Screen. If you need to display nine channels IPC device on the live view window, the sub stream of each IPC must be less than 720P.

## Menu

Click **Menu** to enter the **Menu** interface, it includes IPC Manager, playback, Backup, About, Settings and System. For details, see "3.4 Menu".

## Color Settings

Click **Color Settings** to choose a channel to alter the color, then adjust the parameters of hue, brightness, contrast, saturation and sharpness.

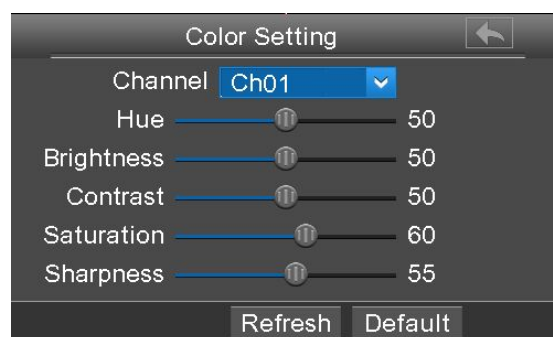

## Playback

You can display the video of every a channel for playback. For details, see "3.4.2



Playback".

## Manual Record

Click **Manual Record** to set manual record for single channel or all channels.

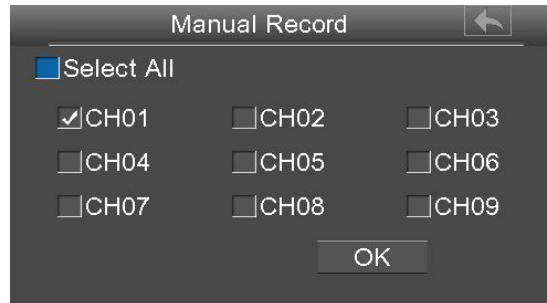

Note: Only FN3109H supports 9 channels, but FN3104H and FN3004H support 4 channels.

### 【Enable Manual Record】

Check the **Channel** checkbox, Click **OK** button to take effect.

Right-click the mouse to back to the Live view interface. In the live view interface, there are icon  at the right bottom of the screen for the channel.

### 【Disable Manual Record】

Uncheck the channel checkbox, Click **OK** button to take effect.

Right-click the mouse to back to the Live view window. In the live view mode, The icon  disappeared at the right bottom of the screen for the channel.

## Adding Devices

You can add and connect the IP Camera, configure the connection of IP cameras, delete the connection of IP camera. For details, see "3.4.1 Adding Devices".



## PTZ

If a channel is connected to IPC which have the PTZ function, you can control the PTZ(Pan, Tilt, Zoom) of the IP Camera.

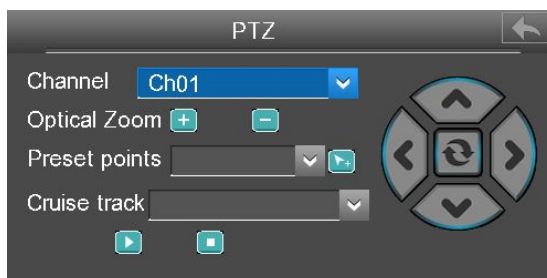
In PTZ control settings, select the channel from the drop-down list.



### 【Optical Zoom】

Configure the zoom of the IP Camera by clicking  or . (This feature only supports IPC devices with zoom function.)

### 【Preset points】

You can select the Preset position from drop-down list, then click  to make the IP Camera move the preset position.

### 【Cruise track】

The default cruise tracks have two types: Vertical and Horizontal.

Vertical: The IP Camera of the channel will rotate from up to down.

Horizontal: The IP Camera of the channel will rotate from left to right.

: Start cruise.      : Stop cruise.

## Shutdown

Click **Shutdown** to enter the Shutdown page. You can log out, reboot or shut down the NVR system.

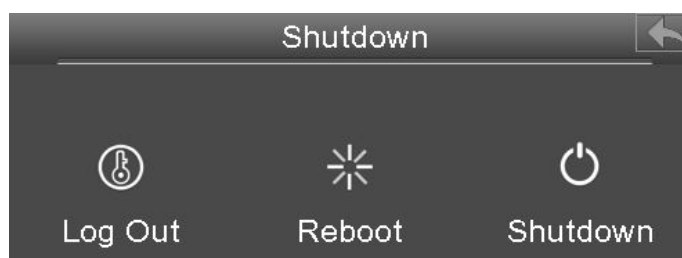

## 3.4 Menu

Right-click in live view mode and select **Menu** from the **Shortcut Menu**, the **Menu**

interface is displayed.

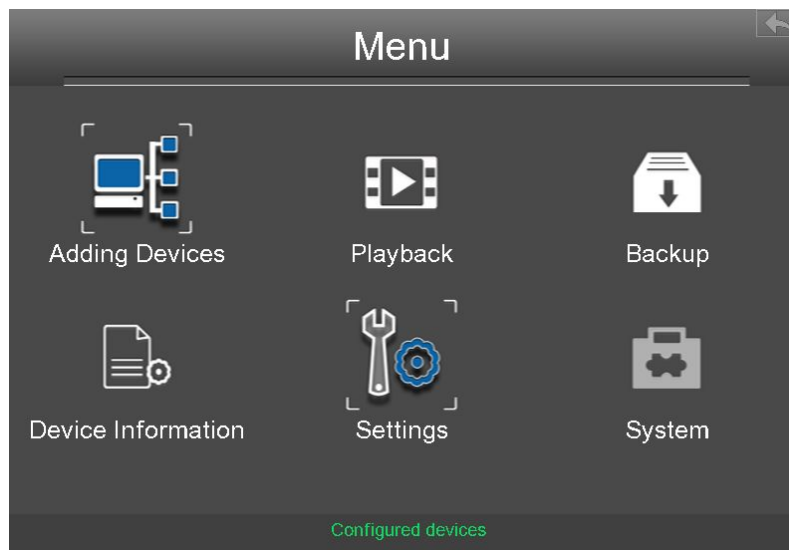

### 3.4.1 Adding Devices

Right-click in live view mode and select **Adding Devices** from the **Shortcut Menu**, or select “Menu > Adding Devices” in the Menu interface. The **Adding Devices** interface is displayed.

You can search and add the online IP cameras by following the operation. After adding IP cameras, the basic information of the camera lists in the **IP Camera List**, and you can configure the basic setting of the IP cameras.



#### **Note**

Before adding the IP Camera, make sure that the IP Camera supports FOSCMA or ONIVF protocol. And you have the username, password and port number of the IP camera.



## Searching IP Cameras

NVR will automatically detect all the online IP Cameras which they can connect to. You will need to know your IP Camera name and password to connect.

If you did not find the online IP Camera which you want to connect, please click **Refresh** button to find the online IP Camera.

## Adding IP Camera

1. Select the IP Camera in the IPC Manager list.

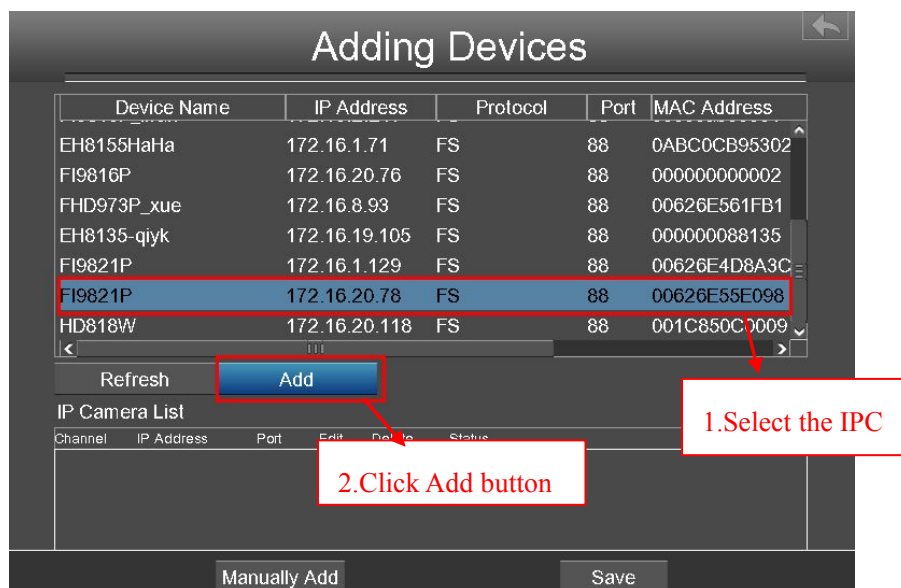

2. Click **Add** button and the following interface will be shown:

Make sure that the IP address of the IPC and NVR's in the same network segment, and the subnet mask and gateway are the same as the NVR's.

Select the protocol for the different IPC.

- FOSCAM protocol: The High Denition(HD) IP Camera of foscam brand.
- MJ protocol: The Standard Denition(SD) IP Camera of foscam brand.
- ONVIF protocol: The IP Camera which supports ONVIF protocol.

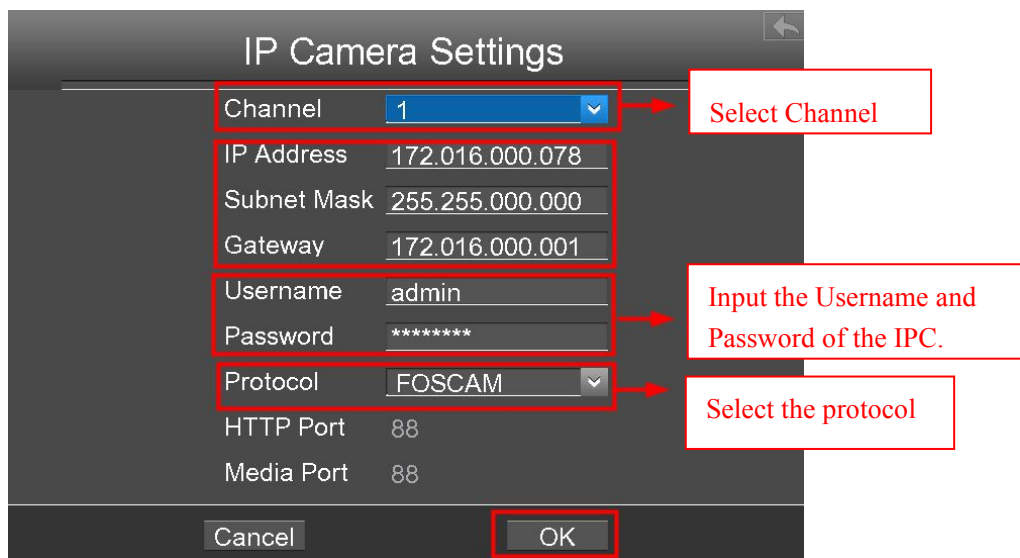

3. Click **OK** button to finish adding. And the camera and its information will be added in the IP Camera list.

4. Click **Save** button to take effect.

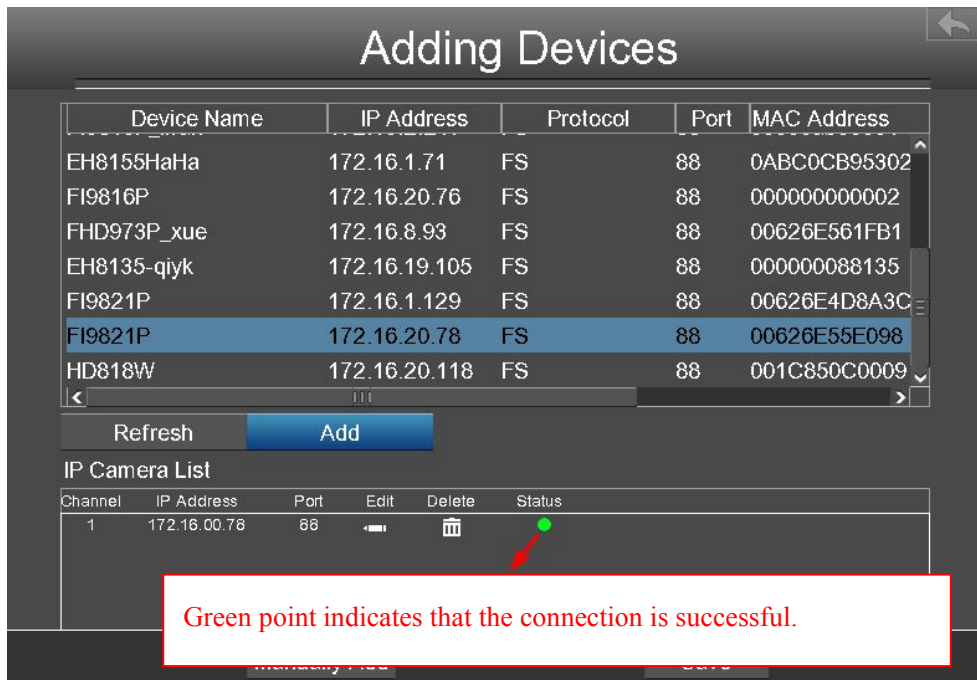

5. Right-Click to return the previous interface.

## Manually Adding IP Cameras

Click **Manually Add** button in the IPC Management interface.

You can select the Channel and Protocol. Input the IP Address, Username, Password, HTTP Port and Media Port.

Then click **OK** button to finish adding.



And the camera and its information will be added in the list of cameras. Click **OK** button to

take effect.

### 3.4.2 Playback

Right-click in live view mode and select **Playback** from the **Shortcut Menu**, or choose "Menu > Playback" in the Menu interface. The **Playback** interface is displayed.



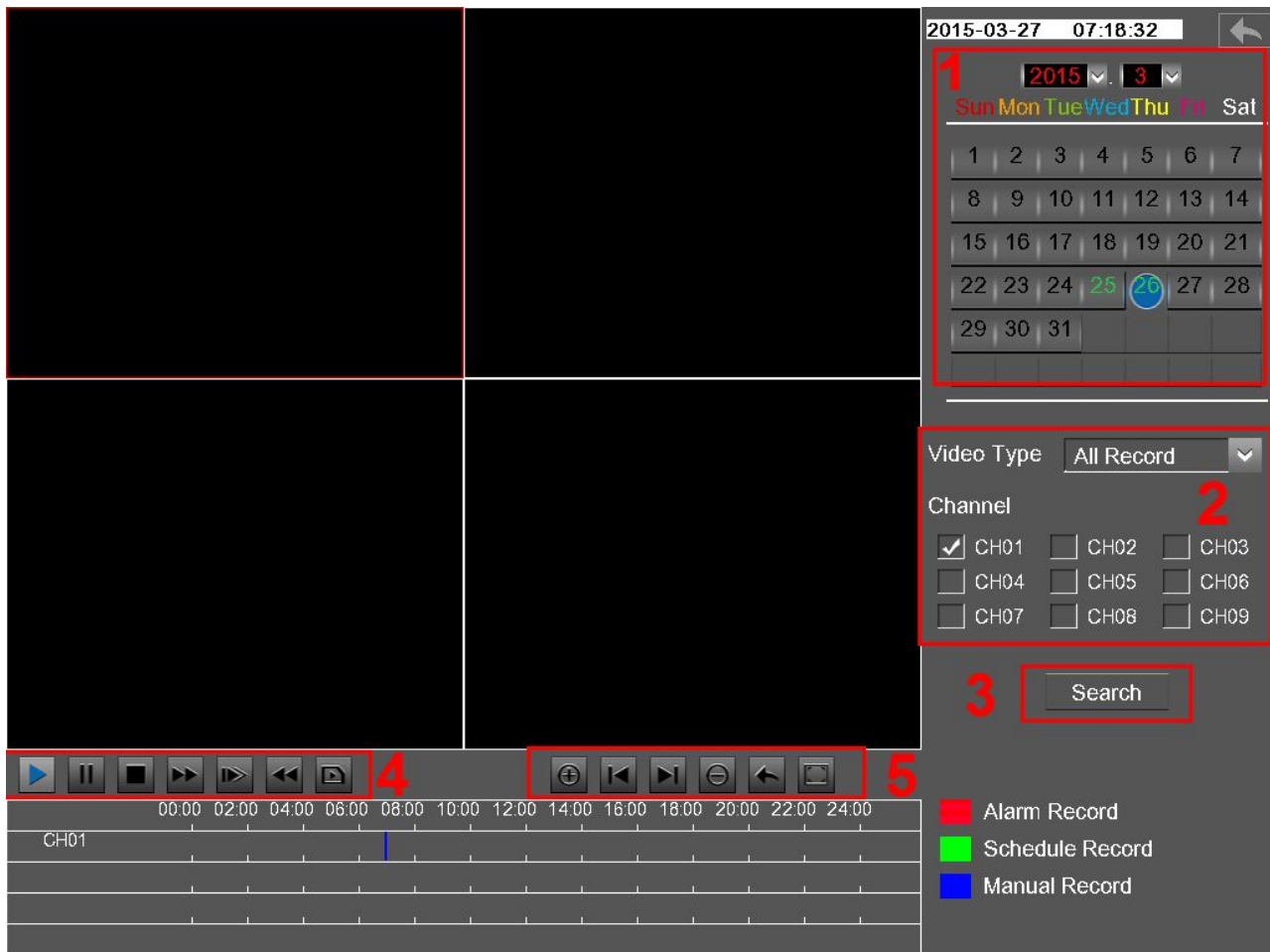



It supports single-screen or four screens.





- 1: Select a date with recording in calendar.
- 2: Select the **Video Type**, and check the checkbox from **Channels**.(Only FN3109H supports 9 channels, but you can select up to four channels for playback at the same time.)
- 3: Click **Search** button to search the matched recorded files. If there are search results, then they will be shown in the time bar area.

Click the icon  to play the recording video.





4: Manage the recording.

Button	Description
	After searching file, click the button to play.
	Pause
	Stop
	Fast forward. The fast forward speed can be twice, 4 times, 8 times, 16 times or 32 times of the normal playing speed. Click this button. The multiple of normal playing speed is displayed in the upper right corner of the playback page. For example, ">> X2" indicates the current playing speed is twice of the normal speed.
	Slow progress. The slow progress speed can be 1/2 times, 1/4 times, 1/8 times, 1/16 times or 1/32 times of the normal playing speed. Click this button. The multiple of normal playing speed is displayed in the upper right corner of the playback page. For example, ">> X1/2" indicates the current playing speed is 1/2 times of the normal speed.
	Fast backward. The fast backward speed can be 4 times, 8 times, 16 times or 32 times of the normal playing speed. Click this button. The multiple of normal playing speed is displayed in the upper right corner of the playback page. For example, "<< X4" indicates the current fast backward speed is four times of the normal speed.
	Frame forward. View the image of each frame.

5: Playback time and maximized video playback

Button	Description
	Zoom-in time axis.
	Left moving time axis.



Button	Description
	Right moving time axis.
	Zoom-out time axis.
	Return to the last playback progress bar.
	Make the playing video maximized. After the video is maximized, right-click to exit the currently maximized video.

### 3.4.3 Backup

Choose "Menu > Backup" in the Menu interface. The **Backup** interface is displayed.

You can search the record information, and export the record information to a mobile storage device for backup. The record type contains **Schedule Record**, **Manual Record** and **Alarm Record**.

#### 【Searching the Record】

Set the log search conditions to refine your search, including the Type, Channel, Date and time of the recording. Then click **Search** button to search the matched recorded files. If there are search results, then they will be shown in list.

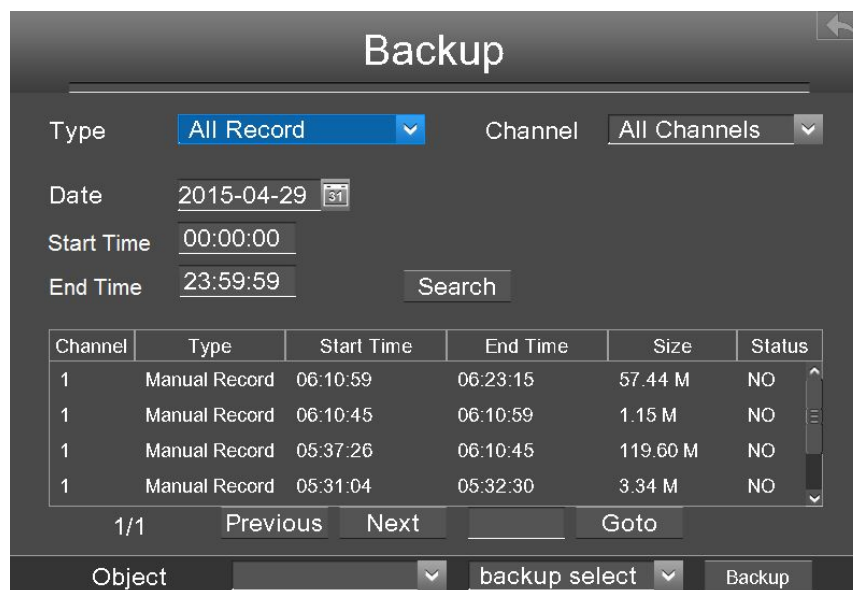

#### 【Backup Record】

The record information can be exported to USB-flash disk for backup.

1. Double-click the record information by the left mouse in the search result list. The status of the Record will change from **No** to **Yes**.
2. After the USB-flash disk connect to the NVR by the USB interface. Select the **Object** from drop-down list.
3. Select the **backup select** from drop-down list.
4. Click **Backup** button and start backup.

**Backup**

Type: All Record Channel: All Channels

Date: 2015-04-29

Start Time: 00:00:00 End Time: 23:59:59

Channel	Type	Start Time	End Time	Size	Status
1	Manual Record	06:10:59	06:23:15	57.44 M	YES
1	Manual Record	06:10:45	06:10:59	1.15 M	NO
1	Manual Record	05:37:26	06:10:45	119.60 M	NO
1	Manual Record	05:31:04	05:32:30	3.34 M	NO

1/1 Previous Next Goto

Object: TOSHIBA Tran backup select Backup

1. Double-click **NO** by the left mouse, the status will change from **No** to **Yes**.

2. Select the object address

3. Click Backup

5. Check backup result.

The system saves the recording to the mobile storage device in the format of MP4. For

example,  CH01\_2014-03-20\_17\_09\_34\_17\_11\_21.mp4 indicates that the video file is created between 2014-3-20 17:09:34 and 17:11:21.

6. When searching for the recording information, you can also select "backup page" or "backup all" to achieve bulk backup.

### 3.4.4 Device Information

Choose "Menu > Device Information" in the Menu interface. The **Device Information** interface is displayed.

You can view the firmware version, manage HDD Info and system log.



## Firmware Version

Choose "Menu > About > Firmware Version" in the Menu interface. The **Firmware Version** interface is displayed. You can view the Device Type, Device Name, Firmware Version and Application Version.



## HDD Info

Choose "Menu > About > HDD Info" in the Menu interface. The **HDD Info** interface is

displayed. You can see, refresh, format backup disk and format record disk.

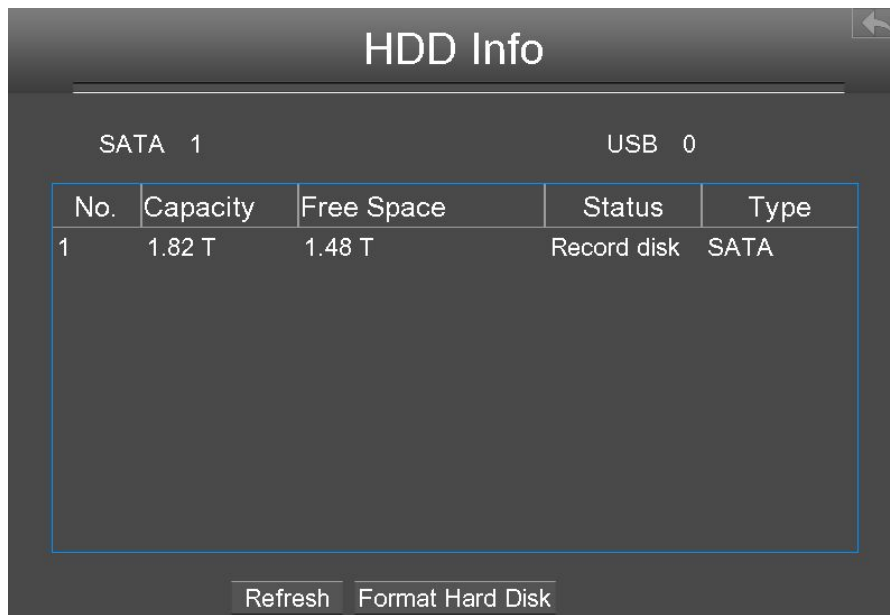

**【 Refresh 】** : Click the **Refresh** button then you can update to the latest information on the hard disk.

**【 Format Hard Disk 】** : If the disk is uninitialized, select the record disk, then click **Format Hard Disk** to format the record disk if the format is incorrect.

## System Log

Choose "Menu > About > System Log" in the Menu interface. The **System Log** interface is displayed. The operation, alarm, exception and information of the NVR can be stored in log files, which can be viewed and exported at any time.

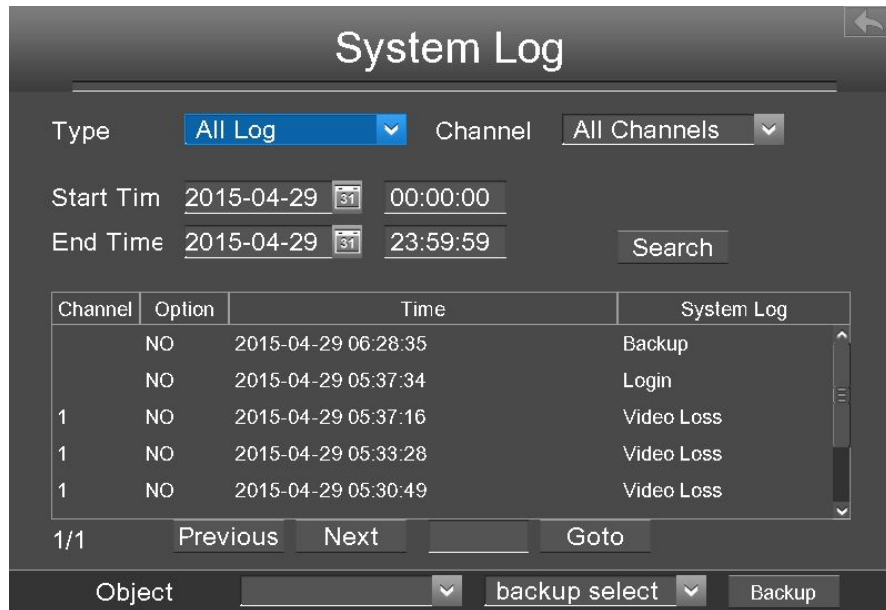

### 【 Searching Log 】

1. Select the log type, channel and time.
2. Click the Search button to list all matched logs.

### 【 Backup Log 】

The log information can be exported to USB-flash disk for backup.

1. Double-click the log information by the left mouse in the search result list. The status of the log will change from No to Yes.
2. After the USB-flash disk connect to the NVR by the USB interface. Select the **Object** from drop-down list.
3. Select the backup select from drop-down list.
4. Click **Backup** button and start backup.
5. Check backup result.

The system saves the log to the mobile storage device. For example, 20140320-134022\_01.log indicates that a log is generated at 2014-3-20 13:40:22.

When searching for the log information, you can also select "backup page" or "backup all" to achieve bulk backup.

## 3.4.5 Settings

Choose "Menu > Settings" in the Menu interface. The **Settings** interface is displayed. You

can configure the general, video, schedule, network, display, Alarm Settings and OSD.

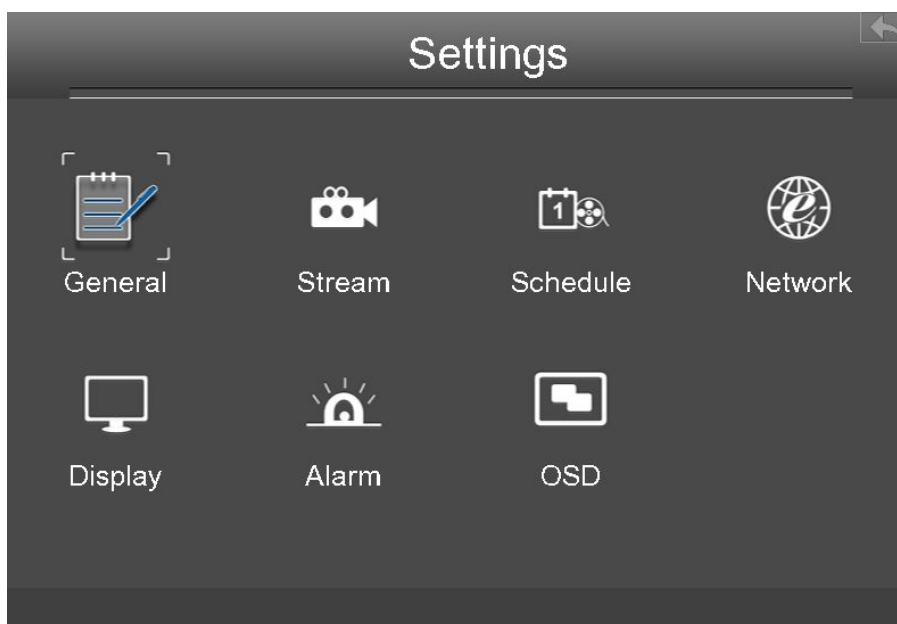

## General

Choose "Menu > Settings > General" in the Menu interface. The **General** interface is displayed. You can configure the basic information of the NVR.

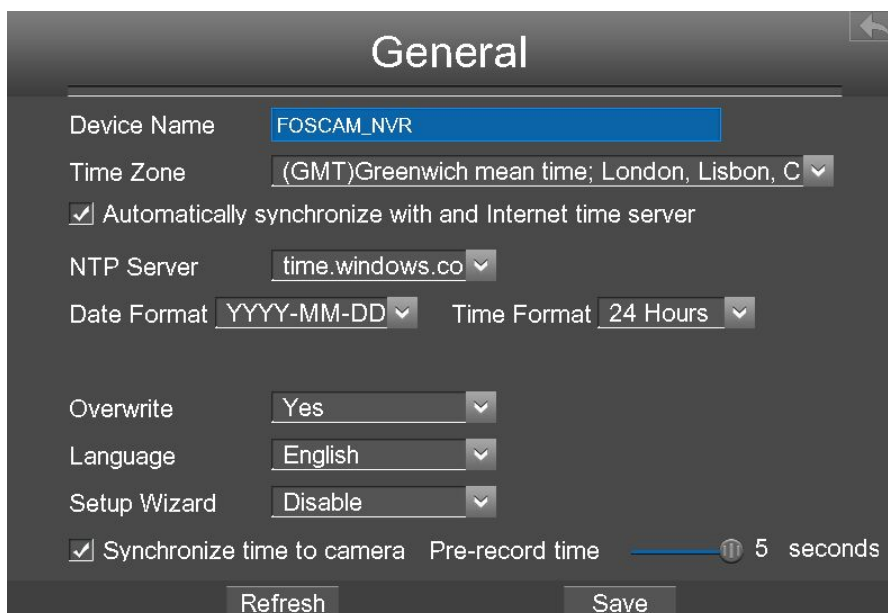

### NOTE

Please do not modify the NVR system time when recording.

Parameter	Description
Device Name	You can modify your device name to help you identify it.

Time Zone	Please select the time zone according to the actual situation.
Automatically synchronize with and Internet time server	Whether synchronize your NVR with an Internet time server. Check: You need to configure the <b>NTP Server</b> . Uncheck: You need to configure the <b>Date and Time</b> .
Date Format	You need to configure the date format.
Time Format	You need to configure the time format.
OverWrite	When the HDD is full. You can select the whether cover the earliest recording.
Language	Configure the language of the NVR interface.
Setup Wizard	Whether to enable startup wizard when the NVR system starts again.
Synchronize time to camera	Time set by the NVR system. Whether to synchronize the time to the connected IPC device.
Pre-recorded time	Pre-recording time. When recording is performed, the system starts recording n seconds before recording is enabled.

Click Save button to take effect.

## Stream

Choose "Menu > Settings > Stream" in the Menu interface. The **Stream** interface is displayed.

You can configure the encoding scheme parameters of the IP Camera, the NVR system will synchronize your IP camera with encoding scheme.

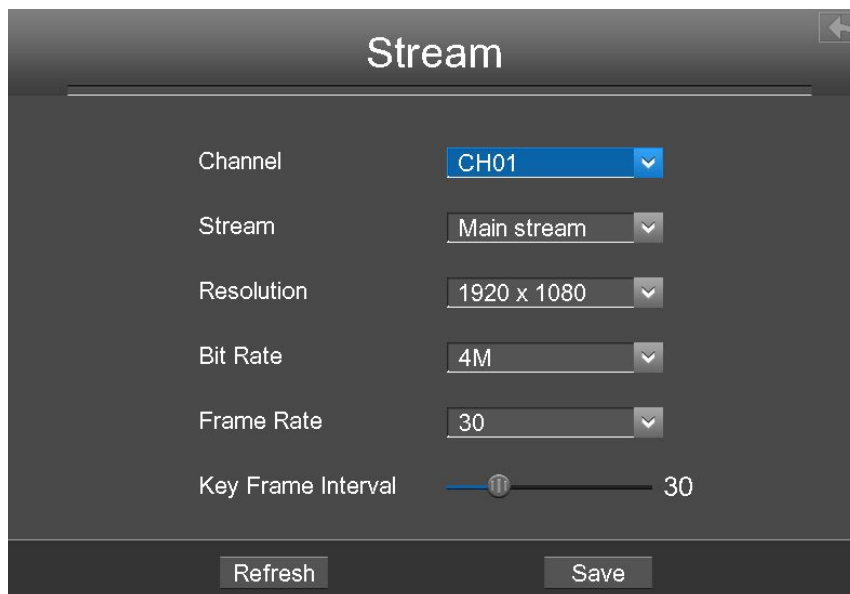

Parameter	Description
Channel	You can select the channel for the IP Cameras.
Stream	You can set the value of Resolution, Bit Rate, Frame Rate, Key Frame Interval when the video was set the main stream.
Resolution	The resolution of the IP Camera. The higher the resolution is, the sharper the video quality is, but also with the increasing stream, which will take up the higher bandwidth.
Bit Rate	Generally speaking, the larger the bit rate is, the clearer video will become. But the bit rate configuration should combine well with the network bandwidth. If the bandwidth is very narrow, and bit rate is large, that will lead to video can not play well.
Frame Rate	Note that a larger frame size takes up more bandwidth. <ul style="list-style-type: none"> <li>● When the video format is 50Hz, the maximum frame rate is 25 fps.</li> <li>● When the video format is 60Hz, the maximum frame rate is 30 fps.</li> </ul> You should choose a lower frame rate when the bandwidth is limited. Normally, when the frame rate above 15, you can achieve fluently video.
Key Frame Interval	The time between last key frame and next key frame. The shorter the duration, the more likely you will get a better video quality, but at the cost of higher network bandwidth consumption.



Click **save** button to take effect.

## Schedule

Choose "Menu > Settings > Schedule" in the Menu interface. The **Schedule** interface is displayed.

You can enable or disable schedule record for the every channel.

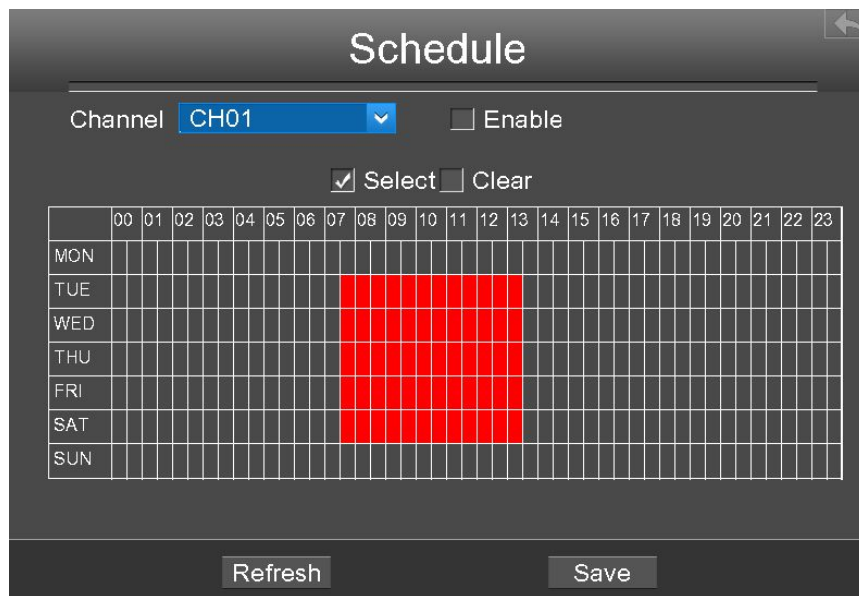

### 【Enable Schedule Recording】

1. Select channel from drop-down box list.
2. Check the **Enable** checkbox to enable Schedule Recording function.
3. Check the **Select** checkbox.

**Note:** Check Clear checkbox and If you clear the area.

4. Click and drag the mouse in the relative positions. The selected area is red.
5. Click Save button to take effect for one certain channel.

The icon  indicate starts schedule recording at the right bottom of the screen for certain channel.

### 【Disable Schedule Recording】

1. Select channel from drop-down box list.

2. Uncheck the Enable checkbox to disable Schedule Recording function.
3. Click Save button to take effect for one certain channel.

## Network

Choose "Menu > Settings > Network" in the Menu interface. The **Network** interface is displayed. You can configure the information of Network, DDNS, E-Mail, FTP.

### 【Network】

Check the **Network** checkbox, you can configure the network information of the NVR.

Parameter	Description
Type	<p>You can select the network type from the drop-down list box.</p> <p>If select the <b>DHCP</b>, NVR system will automatically obtain an IP address and other network settings from that server.</p> <p>If select the <b>Static IP</b>, you can configure an IP address and other network settings.</p>
HTTP Port	The default value is 88.
HTTPS Port	The default value is 443.

IP Address	You can configure the IP address of the NVR system. <b>Note:</b> The IP of IP cameras, PC and NVR should be in the same network segment and in the same LAN.
Subnet Mask	The subnet mask of the NVR system.
Gateway	The gateway of the NVR system.
Primary DNS Server	The primary DNS server of the NVR system.
Alternative DNS Server	The secondary DNS server of the NVR system.
MAC Address	You can use the UPnP function to enable the fast connection of the device to the WAN via a router without port mapping. <b>Note:</b> If you want to enable the UPnP function of the NVR, you must enable the UPnP function of the router to which your NVR is connected.
UPNP	You can enable or disable the UPNP function.

Click **Save** button to take effect.

How to configure the **IP Address**, **Subnet Mask**, **Gateway**, **Primary DNS Server**, **Secondary DNS Server**, please refer to “ Appendix II Common operations > 2. Configure the IP Parameters”.

## 【DDNS】

Check the **DDNS** checkbox, you can configure the DDNS information of the NVR.

The FOSCAM NVR has embedded a unique DDNS domain name when producing, and you can directly use the domain name, you can also use the third party domain name.

The screenshot shows a 'Network' configuration window. At the top, there are four checkboxes: 'Network' (unchecked), 'DDNS' (checked), 'EMail' (unchecked), and 'FTP' (unchecked). Below these, the 'Enable DDNS' checkbox is also checked. The 'Foscam DDNS' field is populated with 'a6747.myfoscam.org'. Under the 'Third Party DDNS' section, the 'DDNS Server' is set to 'None' in a dropdown menu, and the 'Domain' field is empty. At the bottom of the window, there are 'Refresh' and 'Save' buttons.



### Note

Here take *a6747.myfoscam.org* for example.

**Enable DDNS:** Check the DDNS checkbox to enable this feature.

Click Save button to take effect. Then you can use *http:// Domain name + HTTP Port* to access the NVR via internet.

Take hostname **a6747.myfoscam.org** and HTTP Port. **88** for example, the accessing link of the camera via internet would be *http://a6747.myfoscam.org:88*

**Third Party DDNS:** You can also use third part DDNS, such as *www.no-ip.com*, *www.3322.com*. If you set the third party DDNS, refer to the “Appendix II Common operations > 1.Third Party Domain Name Settings”.

### 【EMail】

Check the **EMail** checkbox, you can configure the E-mail information of the NVR.

The system can be configured to send an email to the designated users if an alarm or motion event is detected etc..

Before configuring the Email settings, the NVR must be connected to a local area network (LAN) that maintains an SMTP mail server.

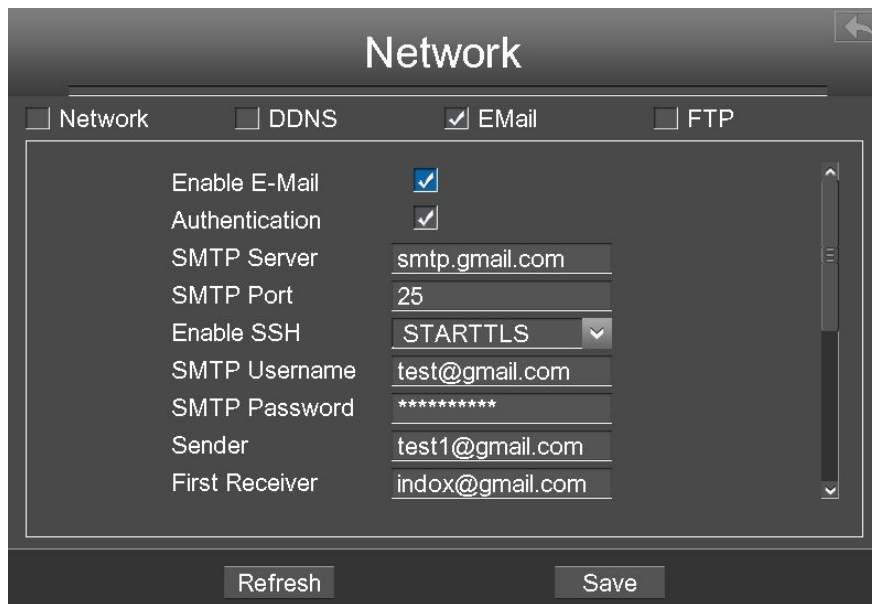

Parameter	Description
Enable E-Mail	Check the checkbox to enable the Eamil function.
Authentication	Whether to verify the user name and password during login to the mailbox.
SMTP Server	The SMTP Server IP address or host name.
SMTP Port	The SMTP port is usually set as 25. Some SMTP servers have their own port, such as 587 or 465.
Enable SSH	Transport Layer Security usually is None.  If you use Gmail, Transport Layer Security must be set to TLS or STARTTLS and SMTP Port must be set to 465 or 25 or 587, which port you choose should be decided by which Transport Layer Security you select.
SMTP Username	The user account of sender's Email for SMTP server authentication.
SMTP Password	The password of sender's Email for SMTP server authentication.
Sender	The Email address of sender.
Receiver	The Email address of user to be notified. you can set 4 receivers

Click **Save** button to take effect.

Click **E-Mail Test** to see if Mail has been successfully configured.

If the test success, you can see the success information, at the same time the receivers will receive a test mail.

**【FTP】**

Check the **FTP** checkbox, you can configure the FTP information of the NVR.

The system can be configured to send an picture to the FTP server if an alarm or motion event is detected etc..

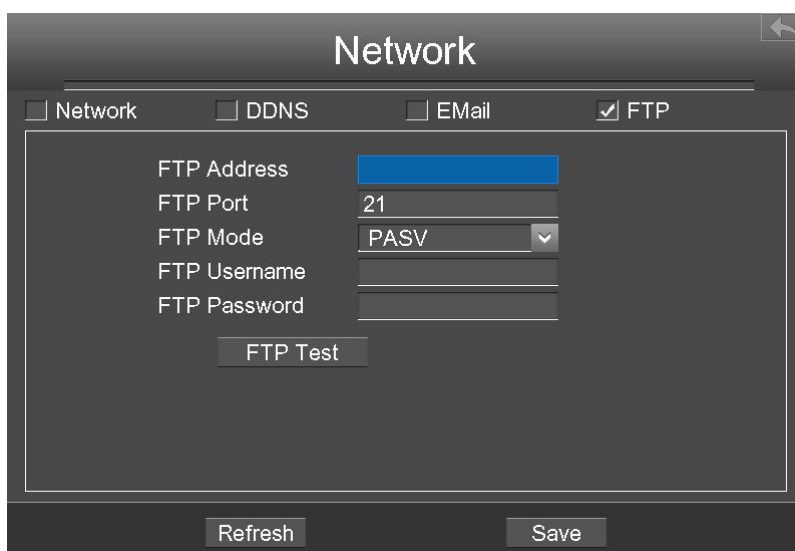

Parameter	Description
FTP Address	<ul style="list-style-type: none"> <li>● If your FTP server is located on the LAN, you can set FTP address as ftp://IP address/dir.(eg.ftp://192.168.1.103/dir).</li> <li>● If your FTP server is located on the WAN, you can set FTP address as ftp://domain name/dir.(eg.ftp:test.no-ip.org/dir).</li> </ul>
FTP Port	Default port is 21.You can also change this port manually through FTP server.
FTP Mode	Here supports two modes: PORT and PASV.
FTP Username	The user account of FTP server.
FTP Password	The user password of FTP server.

Click **Save** button to take effect.

Click **FTP Test** to see if FTP has been successfully configured.

If the test success, you can see the success information.

## Display

Choose "Menu > Settings > Display" in the Menu interface. The **Display** interface is displayed. You can configure the display mode, Resolution, Transparency, Mouse Sensitivity and Interval for the NVR.



Parameter	Description
Resolution	The output resolution of the NVR.
Transparency	Configure the transparency of the NVR output interface.
Mouse Sensitivity	Configure the sensitivity of the mouse.

## Alarm Settings



### 【External Alarm】

**Note:**FN3004H do not support the External Alarm function.

Choose "Menu > Settings > Alarm Settings > External Alarm" in the Menu interface. The **External Alarm** interface is displayed.

External alarm input devices are connected through the alarm input interface and external alarm output devices are connected through the alarm output interface. After the devices are connected successfully, you can configure information about the external alarm devices. When an external alarm input device triggers an alarm, the NVR system transmits the alarm information to an external alarm output device, which makes corresponding response.

In the live view mode, there are icons at the right bottom of the screen for each channel.

- The Icon  indicate alarm was triggered.
- The Icon  indicate the IPC is recording.

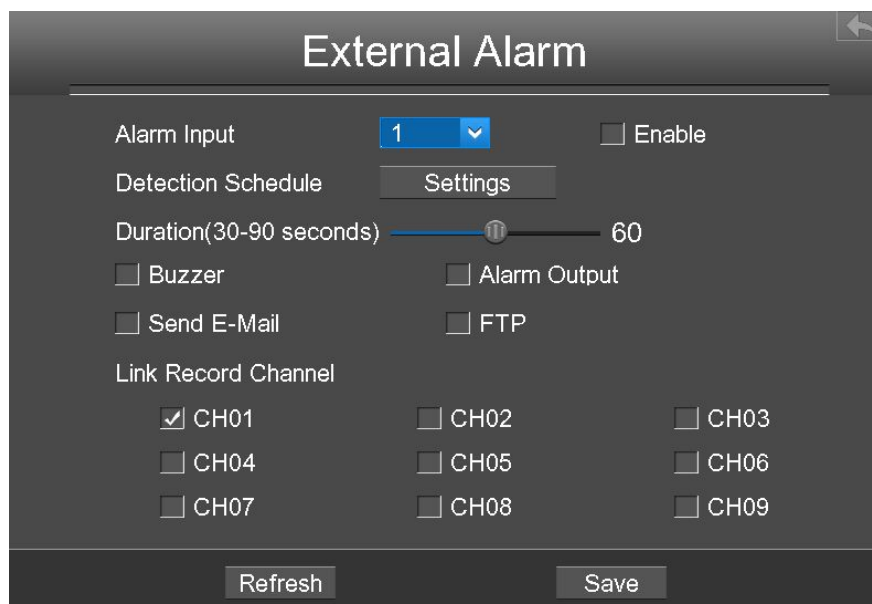

**Step1** Select the **Alarm Input** from drop-down box list.

**Step2** Check the **Enable** checkbox to enable IO Alarm function.

**Step3** Set Detection Schedule

1. Click **Settings** button for the Detection Schedule.

Set up arming schedule of the channel for the IO alarm.

You can choose a week, one day of a week, the certain time period for the motion detection alarm.

2. Check **Select** checkbox to select the area.
3. Drag and draw the area for motion detection by left mouse.

**Note:** Check **Clear** checkbox and If you clear the area, then drag and draw the area by



mouse.

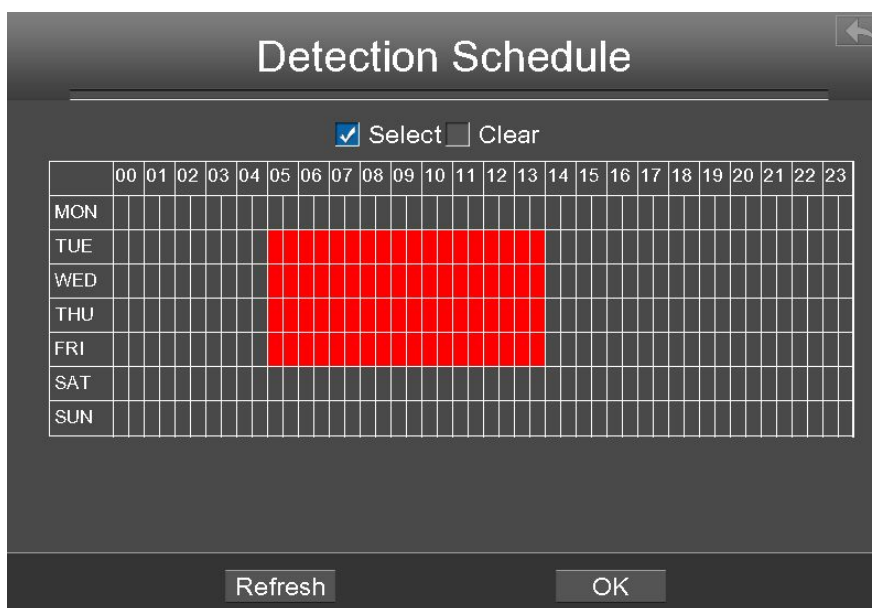

4. Click the **OK** button to save and exit the window.

**Step4** Set the duration from drop-down box list. It indicates the duration of the alarm and alarm linkage recording.

**Step5** Check the checkbox to select the linkage method. You may refer to follow table for details of linkage methods.

Parameter	Description
Buzzer	When the IO Alarm is triggered, you can choose whether to enable buzzing sound of the NVR device.
Alarm output	When the IO Alarm is triggered, you can choose whether to alarm via the alarm output device. <b>Note:</b> Make sure you have installed the alarm output device.
Send E-mail	When the IO Alarm is triggered, you can choose whether to send e-mail. <b>Note:</b> Make sure you have set Email.
FTP	When the IO Alarm is triggered, you can choose whether to upload detection picture to FTP server. <b>Note:</b> Make sure you have set FTP.
Linkage Record	Check the checkbox to start recording for the certain channel.

Channel	
---------	--



Step6 Click **Save** button to take effect.

-----End

**【Motion Detection】**

Follow the steps to set the motion detection parameters. In the live view mode, once a motion detection event takes place, the NVR can analyze it and perform many actions to handle it. Enable motion detection function can trigger certain channels to start recording, or trigger full screen monitoring, output alarm, send Email, upload figure to FTP, buzzer alarm and so on.

In the live view mode, there are icons at the right bottom of the screen for each channel.

- The Icon  indicate alarm was triggered.
- The Icon  indicate the IPC is recording.

In this chapter, you can follow the steps to schedule a record which triggered by the detected motion.

Choose "Menu > Settings > Alarm Settings > Motion Detection" in the Menu interface. The **Motion Detection** interface is displayed.

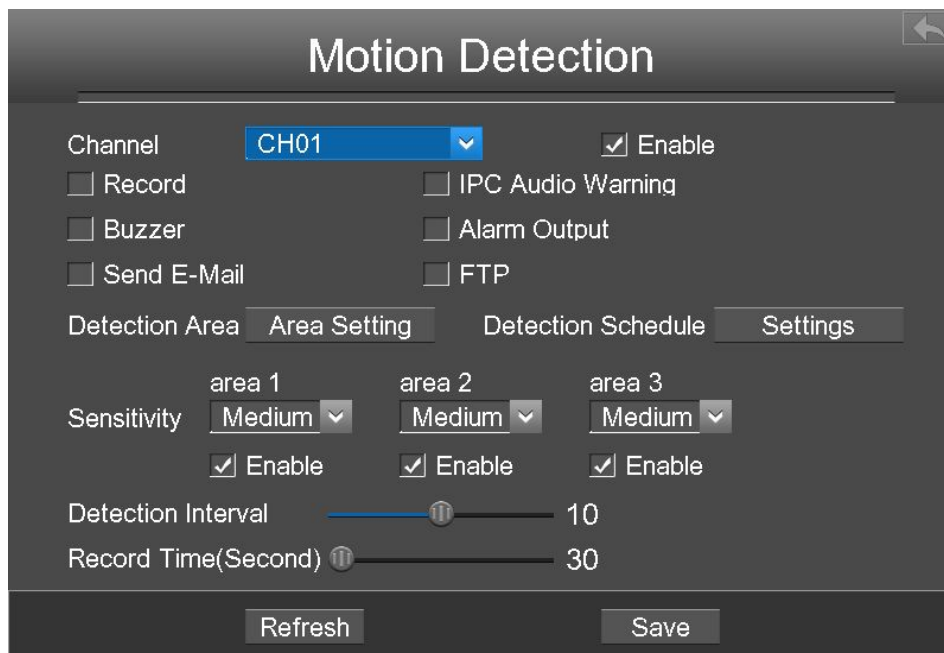

Step1 Select channel from drop-down box list.

**Step2** Check the checkbox to enable motion detection function.

**Step3** Check the checkbox to select the linkage method. You may refer to follow table for details of linkage methods.

Parameter	Description
Record	If you select this checkbox, when the Motion detection is triggered, the NVR will record automatically and store the record files to the HDD.
IPC Audio Warning	If you select this checkbox, when the Motion detection is triggered, the people around the camera will hear beep alarm sound of the IPC.
Buzzer	When the Motion detection is triggered, you can choose whether to enable buzzing sound of the NVR device.
Alarm Output	When the IO Alarm is triggered, you can choose whether to alarm via the alarm output device. <b>Note:</b> Make sure you have installed the alarm output device. FN3004H do not support Alarm Output function.
Send E-Mail	When the Motion detection is triggered, you can choose whether to send e-mail. <b>Note:</b> Make sure you have set Email.
FTP	When the Motion detection is triggered, you can choose whether to upload detection picture to FTP server. <b>Note:</b> Make sure you have set FTP.

**Step4** Set Detection Area.

1. Click **Set** button and it pop up a window.
2. Drag and draw the area for motion detection by left mouse.
3. Right-click with your mouse to save and quit. When something moving in the detection area, the NVR will alarm.

**Step5** Set Detection Schedule.

1. Click **Settings** button for the detection schedule.

Set up arming schedule of the channel for the motion detection.

You can choose a week, one day of a week, the certain time period for the motion detection alarm.

2. Check **Select** checkbox to select the area.
3. Drag and draw the area for motion detection by left mouse.

**Note:** Check **Clear** checkbox and If you clear the area, then drag and draw the area for motion detection by mouse.

4. Click the **OK** button to save and exit the window.

**Step6** Select the **Sensitivity** from the drop-down box list. And then you can enable the detection area.

You can drag the time bar to select the detection interval and record time.

Parameter	Description
Sensitivity	The higher the sensitivity, the NVR will be more easily alarmed.
Detection Interval	The Triggered Interval time between two motion detection. The unit is second.
Record Time (Second)	When you check the <b>Record</b> , you need to configure motion detection recording time. The unit is second.

**Step7** Click Save button to take effect.

When the motion has been detected during the detection time in the detection area, the NVR will alarm and adopt the corresponding alarm linkage.

**Note:** You must set the detection area and detection schedule, or else there is no alarm anywhere and anytime.

-----End

### 【Other Alarm】

Choose "Menu > Settings > Alarm Settings > Other Alarm" in the Menu interface. The **Other Alarm** interface is displayed. You can configure the HDD(Hard Disk Drive) information.

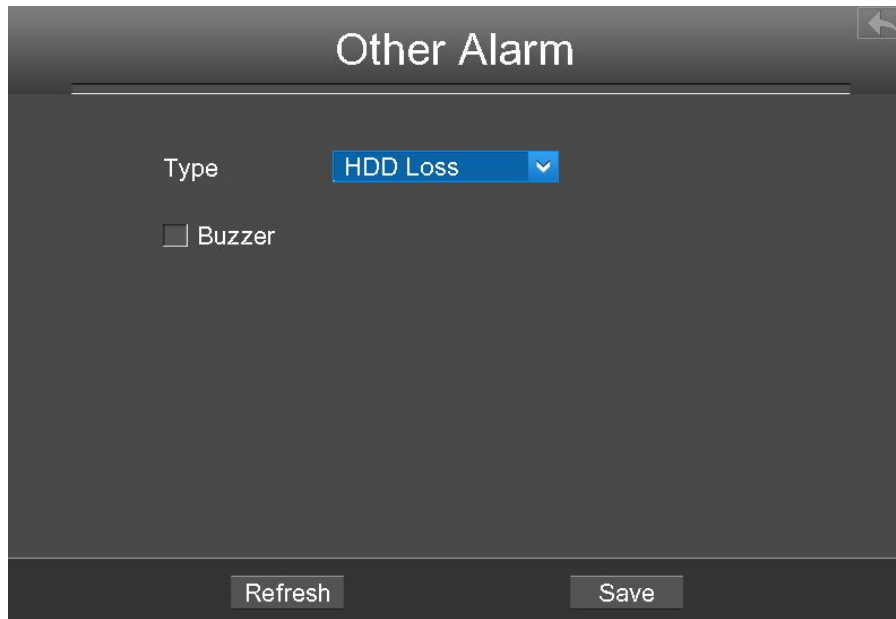

Parameter	Description
Type	Select <b>Type</b> form drop-down box list. It contains HDD Loss, HDD Saturation, HDD Error, Video Loss and Network Error.
Buzzer	Check the <b>Buzzer</b> checkbox if you want to enable buzzing sound of the NVR device.

Click **Save** button to take effect.

## OSD

Choose "Menu > Settings > OSD" in the Menu interface. The **OSD** interface is displayed. You can configure the OSD(On Screen Display) information.

Parameter	Description
Channel	Select the channel from the drop-down list.
Channel Name	It displays the IPC device name of the corresponding channel.
Display Channel Name	Whether to display the IPC device name on the selected channel.
Display Time	Whether to display the IPC device time on the selected channel.
Enable Mask	Check the <b>Enable Mask</b> checkbox to enable OSD function.

### 【Set Shelter Area】

If the IPC device type is MJ or IPC protocol type is ONVIF, the feature is invalid.

1. Click **Select Shelter Area** button and it pop up a window.

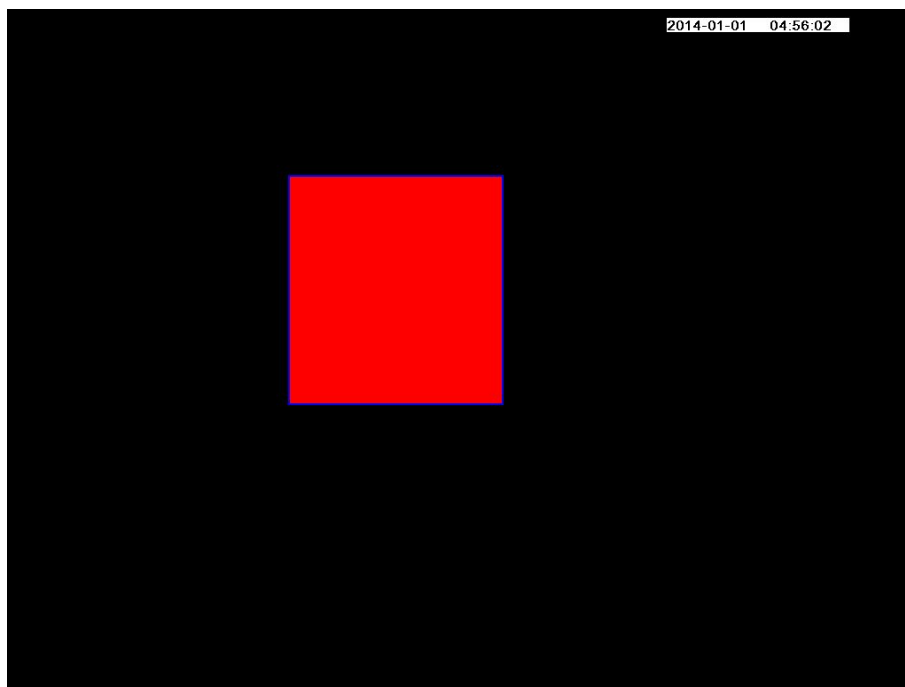

2. Drag and draw the area for privacy zone by left mouse.

**Note:**To clear the privacy area, double click the mouse.

3. Right-click with your mouse to save and quit.

Click **Save** button to take effect.

### 3.4.6 System

Choose "Menu > System" in the Menu interface. The **System** interface is displayed.

You can manage the NVR device about User Account, Upgrade, Factory Reset, Para export, Auto Restore, Log Out, Reboot, Shutdown.

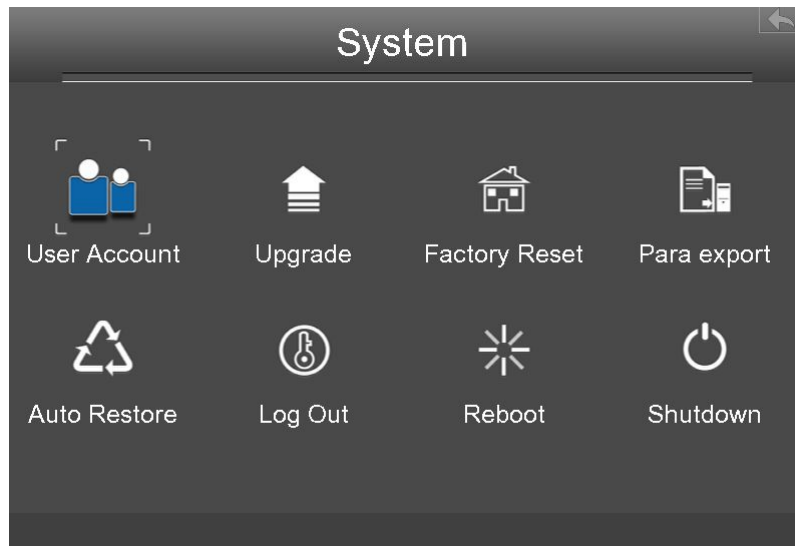

## User Account

Choose "Menu > System > User Account" in the Menu interface. The **User account management** interface is displayed.

User levels by permission from low to high are visitor, operator, administrator. Different user levels have different operating permission. The default user name of device administrator is admin with no password.

The administrator has the permission to add and delete all users and configure user parameters.

You can add, modify, delete username/password or distribute authority for users.

The valid value range of Username and Password is 1 ~ 20 characters, it contains the English letter, numeric and symbol.



No.	Username	Password	Competence	Enable
1	admin	****	Administra	<input checked="" type="checkbox"/>
2	opr	***	operator	<input checked="" type="checkbox"/>
3	vis	***	visitor	<input checked="" type="checkbox"/>
4			visitor	<input type="checkbox"/>
5			visitor	<input type="checkbox"/>
6			visitor	<input type="checkbox"/>
7			visitor	<input type="checkbox"/>
8			visitor	<input type="checkbox"/>

Refresh Save

After configure the username, password and competence, you need to check Enable checkbox. Then click **Save** button to take effect.

## Upgrade

Choose "Menu > System" in the Menu interface, then click **upgrade** in the **System** interface. You can check for updates by network or upgrade by local.

### 【Local upgrade】

First, a mobile storage device needs to be inserted by the USB interface and the NVR system upgrade file **upgrade.bin** has been stored in the root directory of the mobile storage device.

Click **Local upgrade** in the Upgrade interface, and then click **OK** button to start upgrade in the pop-up message box.

### NOTE:

Don't shut down the power during upgrade. After upgrading, you can see the upgrade result.

## Factory Reset

Choose "Menu > System" in the Menu interface, then click **Factory Reset** in the System interface.

Click **OK** button in the pop-up message box and all parameters will return to factory

settings. Click **OK** button and then the NVR device will reboot automatically.

## Para export

Choose "Menu > System" in the Menu interface, then click **Para export** in the System interface. You can import or export a configuration file for NVR system.

### 【Config Export】

It is used to save your current settings. It is recommended to backup your configuration before modifying or upgrading firmware.

Click **Config Export**, and then click **OK** button in the pop-up message box. The configuration files of the NVR will be exported to USB-flash disk for backup. The name of the configuration file name is config.bin.

### 【Config Import】

Click **Config Import**, and then click **OK** button in the pop-up message box. The configuration file from the USB-flash disk will be import.

The loading process takes about 50 seconds, After having finished the import of configuration files, the NVR device will reboot automatically.



### Note

- Do not disturb the update process by turning off the power.
- All current settings will be overwritten when importing a configuration file. If a bad configuration file is uploaded the NVR may not work.

## Auto Restore

Choose "Menu > System > Auto Restore" in the Menu interface. The **Auto Restore** interface is displayed.

You can configure the Date and Time. The NVR will maintain system at the setting time.

## Log Out

After logging out, the monitor turns to the live view mode and if you want to do some operation, you need to input user name and password tog in again.

Choose "Menu > System" in the Menu interface, then click **Log Out** in the System interface. Click **OK** button in the pop-up message box, the NVR system will log out.

**Note:** After you have logged out the system, menu operation on the screen is invalid. It is required to input a user name and password to unlock the system.

## Reboot

Choose "Menu > System" in the Menu interface, then click **Reboot** in the System interface. Click **OK** button in the pop-up message box, the NVR system will reboot.

## Shutdown

Choose "Menu > System" in the Menu interface, then click **Shutdown** in the System interface.

Click OK button in the pop-up message box, the NVR system will shut down.

It is recommended that cut off the power after shut down.

You can start up/shut down the NVR by the IR Remote Control(Only FN3104H).

You can access and manage the NVR on a PC through Web browser.

## 4.1 Instructions before Login

Before accessing the NVR by using the Web browser, you need to obtain the following information:

- The NVR and the PC must be connected to the same LAN and are in the same network segment.
- You can query or allocate the IP address of the NVR by using the following methods:  
Through operation on the local GUI, configure an IP address for the NVR. For the specific operation, see “ Appendix II Common operations > 2. Configure the IP Parameters”.  
Allocate an IP address for the NVR through a router.
- This product supports 32-bit IE8 or later versions and does not support 64-bit IE browsers. It also supports Apple Safari and Mozilla Firefox browsers.

## 4.2 Login

**Step1** Log in to the Web client of the NVR. You can directly enter the IP address and port in the browser or search out the NVR by using the FOSCAM search tool. Here we take FOSCAM search tool as an example.

**Step2** Find the folder “Equipment Search Tool” in the Foscam CD, then go to the the folder”For windows OS” or “For Mac OS”. Copy and paste the search tool file to your computer, or drag it onto your desktop.



Shortcut icon for Windows / Mac OS

**Step3** Enable the DHCP feature of your router, then open the Equipment Search Tool program. It should display the NVR’s IP address in your LAN.

Camera Name	IP Address	Device ID	Type
Anonymous	Http://192.168.1.105:88	00626E55AB1E	NVR



**Note**

If there are multiple devices, you need to obtain the IP address and port of the NVR using the local GUI. For details, see “3.4.5 Settings > Network”.

**Step4** Double-click the NVR, and your default browser will open up to the NVR’s login page. When logging in for the first time, you will need to install the add-on.

It will pop up the message below the page, as shown in the following figure.

Click **Install** button to install the add-on. Please follow the installation instructions. (Please close the browser during installation.)

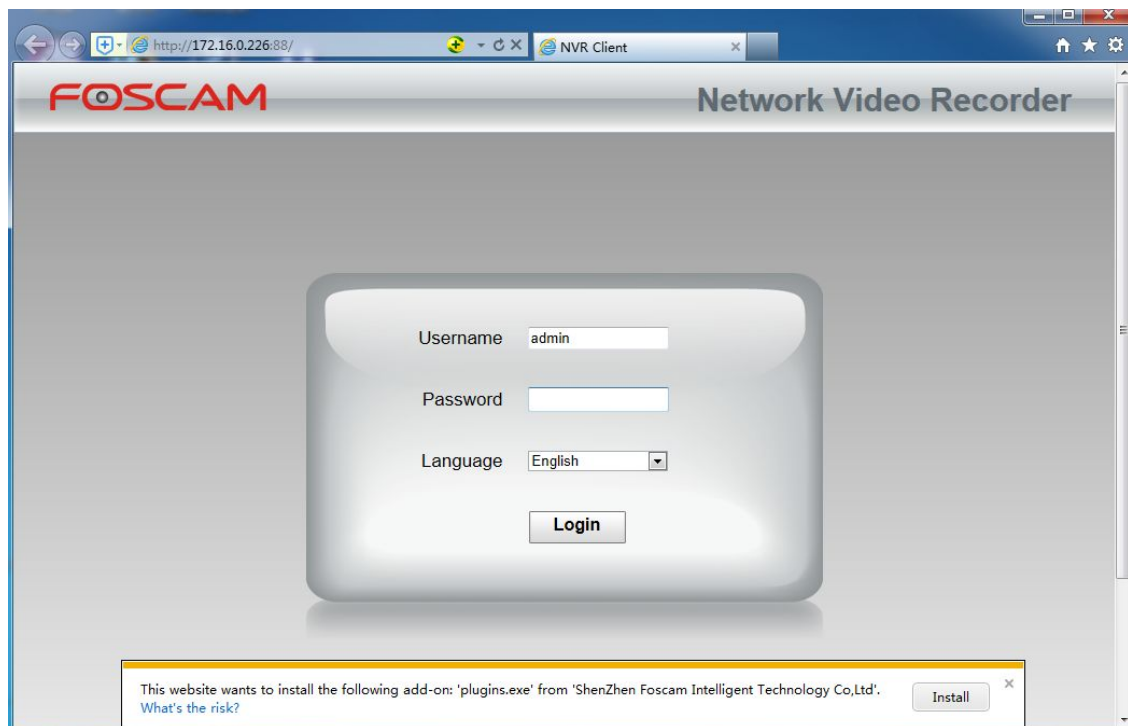

**Step5** After installing the add-on, refresh the browser and enter the login interface.



Input the follow parameter.

Parameter	Description
Username/Password	The user name and password of the NVR client. The default administrator username is admin with a blank password, please set the new username or password at first using and prevent unauthorized users login the NVR.
Language	Select the language type of the NVR client.

Step6 Click **Login** button.

Step7 When you log in for the first time, it will come to the operating of modify the username and password automatically. Enter the New Username, New password and Confirm the password.





Step8 Click **Modify** button, you will see the **Live View** interface of the NVR client.









-----End

## 4.3 Live Video







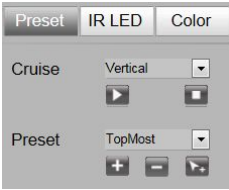

After login, the live view interface will display. You can configure the play/stop the live view, manual recording, manual capturing, preset, cruise, led, color and so on.



Section	Icon	Name	Description
1		Live Video	Click this button and back to the realtime preview window.
		Parameter Configuration	There are Local Settings, Settings, Service Configuration, User Management, System Management in the Parameter Configuration interface.
		Playback	Play back the recorded video files of a specific channel in the live view mode.
		Logout	Disconnect the link between the client page of the current browser and the NVR server.

2		Channels	In channels of the NVR, you can add IPC devices. The FN3109H supports 9 channels, the FN3104H and FN3004H support 4channels.  Note: If you need to display nine channels IPC device on the live view window, the sub stream of each IPC must be less than 720P.
		Play	Play an IPC monitoring video in a channel of the NVR. By default, the video is played.
		Stop	Stop playing the monitoring video in the channel.
		Take Snapshot	Select the channel, click this button, and you can take a snapshot of the monitoring video page of a corresponding channel to the local computer. You can set the storage path, refer to the "Web > Parameter configuration > Settings > Storage Location".
		Record	Click this button to manually record the content on the monitoring page. The recorded content is stored in the HDD of the NVR.
3		Optical Zoom	Click this button, the IP Camera lens focal will be bigger or smaller, you can adjust the focal length, according to the target object distance to obtain high-resolution images.(only supported with zoom function of IPC).
		PTZ	The configuring of the PTZ parameters should be done before you control the PTZ camera.  Use the directional button to wheel the camera to the location where you want to set preset.  indicates the IP camera go to the default center.  Only the IP camera with PTZ supports this feature.
4		Preset	You can configure the preset and cruise of the IP Camera.



		IR LED	You can configure the LED of the IP Camera. There are two modes: Manual and Auto.
		Color	You can configure the color of the IP Camera.
5		Play all	Play monitoring videos in all channels.
		All off	Close monitoring videos in all channels.
4		1 Channel	Click this button, It will display one channel in the live view interface.
		4 Channels	Click this button, It will display four channels in the live view interface.
		9 Channels	Click this button, It will display 9 channels in the live view interface. Only FN3109H supports this function.
		Full Screen	Click this button or double-click the monitoring page to make the monitoring page displayed in full screen. Press Esc to exit full screen mode.

## Setting Cruise



The default cruise tracks have two types: Vertical and Horizontal.

Vertical: The IP camera will rotate from up to down.

Horizontal: The IP camera will rotate from left to right.

: Start cruise.      : Stop cruise.

If you want to define or change the cruise trace, please go to “Parameter Configuration > Service configuration > Preset Settings”.

### 【 How to do cruise? 】

Step1 Select one track in the track drop-down list.

Step2 Click , the IP camera will cruise following the predefined path.

Step3 Click  and finish cruising.

## Preset settings

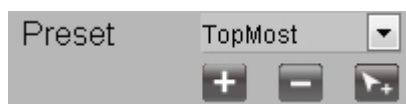

The default preset position is TopMost, BottomMost, LeftMost, RightMost, you can add other preset positions.



 Add: Click this icon to save the position you need the IP camera to remember.

 Delete: Select one preset position and click this button to delete it.

 GO: Select one preset position in the preset drop-down list and click Go to make the IP camera move the preset position.

### 【 How to do preset position? 】

Step1 Rotate the IP camera and stop at a desired place where you want make preset position.

Step2 click  button and input a descriptive name for the preset position. The preset position cannot contain special characters. Then click  to save it. If you want to reset the preset position, click .

You can move the IP camera and stop at another place, and set another preset position. You can do all the preset positions with this method.

Step3 If you want to see one preset position you have set, only select the preset position name from the preset drop-down list, and click  button, the IP camera will go to the preset position.

## 4.4 Parameter Configuration

Choose  (Parameter Configuration)", you can configure the Local Settings, Settings, Service Configuration, User Management, System Management and so on.

## 4.4.1 Local Settings

### Firmware Version

You can view the NVR system information, or modify the **Device Name**.

Choose " (Parameter Configuration) > Local settings > Firmware Version". The **Firmware Version** page is displayed.

### Firmware Version

Device Type	<input type="text" value="FN3109H"/>
Device Name	<input type="text" value="FOSCAM_NVR"/>
System Firmware Version	<input type="text" value="2.1.1.3"/>
Application Firmware Version	<input type="text" value="1.31.02.02"/>
Plug-in Version	<input type="text" value="2.0.0.2"/>

Parameter	Description
Device Type	The product type of NVR.
Device Name	The device name is a unique name that you can give to your device to help you identify it. You can change your NVR name.
System Firmware Version	Display the system version of your NVR.
Application Firmware Version	Display the application firmware version of your NVR.
Plug-in version	Display the plug-in version of your NVR.

Click **Save** button to take effect.

### System Time

You can configure the date and time of the NVR.

Step1 Choose " (Parameter Configuration) > Local settings > System Time". The **System Time** page is displayed.

Step2 Configure the system time of the NVR.

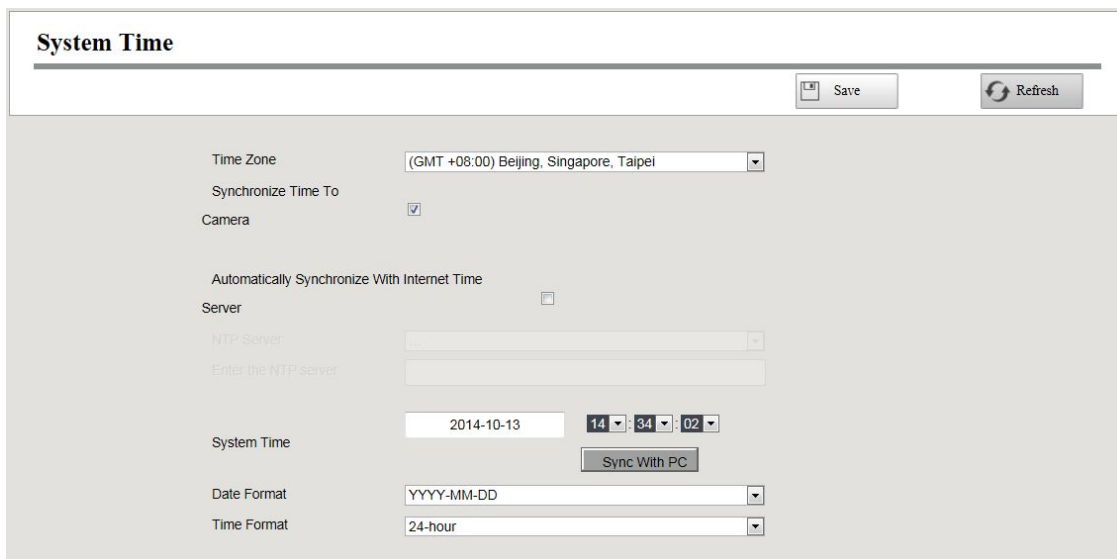

**Step3** Select the **Time Zone** from the drop-down list.

**Step4** If you check the **Synchronize Time To Camera** checkbox, the default settings of the NVR for the IP camera is applied to the added camera.

**Step5** Configure the system date and time.

- If you check the **Automatically Synchronize With Internet Time Server** checkbox, a Network Time Protocol (NTP) Server can be configured on your NVR to ensure the accuracy of system date/time. Choose the one that is closest to your NVR.
- If you uncheck the **Automatically Synchronize With Internet Time Server** checkbox, configure the following NTP settings.

Parameter	Description
System Time	There are two different ways for the date format to synchronize the date and time of the NVR. <ul style="list-style-type: none"> <li>● input the date and time manually. .</li> <li>● Click <b>Sync with PC</b> button to synchronize the date and time of the NVR system with your computer.</li> </ul>
Date Format	Select the date format from the drop-down list.
Time Format	Select the time format from the drop-down list.

**Step6** Click **Save** button to take effect.

-----**End**

## Network

You can configure the network information of the NVR.

Step1 Choose " (Parameter Configuration) > Local settings > Network". The **Network** page is displayed.

## Network

Network Type	<input type="text" value="DHCP"/>
HTTP Port	<input type="text" value="88"/>
HTTPS Port	<input type="text" value="443"/>
IP Address	<input type="text" value="172.16.0.65"/>
Subnet Mask	<input type="text" value="255.255.0.0"/>
Gateway	<input type="text" value="172.16.0.1"/>
Primary DNS Server	<input type="text" value="0.0.0.0"/>
Alternative DNS Server	<input type="text" value="192.168.8.8"/>
UPNP	<input type="text" value="Enabled"/>

Step2 Configure the network parameter.

Parameter	Description
Network Type	You can select the network type from the drop-down list box. <ul style="list-style-type: none"> <li>● If select the <b>DHCP</b>, the NVR system will automatically obtain an IP address and other network settings from that server.</li> <li>● If select the <b>Static IP</b>, you can configure an IP address and other network settings.</li> </ul>
HTTP Port	The default value is 88.
HTTPS Port	The default value is 443.
IP Address	You can configure the IP address of the NVR system. <b>Note:</b> The IP of IP cameras, PC and NVR should be in the same network segment and in the same LAN.
Subnet Mask	The subnet mask of the NVR system.
Gateway	The gateway of the NVR system.
Primary DNS Server	The primary DNS server of the NVR system.
Alternative	The secondary DNS server of the NVR system.

Parameter	Description
DNS Server	
UPNP	<p>You can use the UPnP function to enable the fast connection of the device to the WAN via a router without port mapping.</p> <p><b>Note:</b></p> <p>If you want to enable the UPnP function of the NVR, you must enable the UPnP function of the router to which your NVR is connected.</p>

How to configure the **IP Address, Subnet Mask, Gateway, Primary DNS Server, Secondary DNS Server**, please refer to “ Appendix II Common operations > 2. Configure the IP Parameters”.

Step3 Click **Save** button to take effect.

-----End



## Email

The system can be configured to send an email to the designated users if an alarm or motion event is detected etc..

Before you configure the Email settings, the NVR must be connected to a local area network (LAN) that maintains an SMTP mail server. The network must also be connected to either an intranet or the Internet depending on the location of the e-mail accounts to which you want to send notification.

Step1 Choose " (Parameter Configuration) > Local settings > Email". The **Email** page is displayed.

### Email

 Save  Refresh

Enable E-Mail	<input type="text" value="Open"/>
Authentication	<input type="text" value="Open"/>
SMTP Server	<input type="text"/>
SMTP Port	<input type="text" value="25"/>
Transport Layer Security	<input type="text" value="None"/>
SMTP Username	<input type="text"/>
SMTP Password	<input type="password"/>
Sender	<input type="text"/>
First Receiver	<input type="text"/>
Second Receiver	<input type="text"/>
Third Receiver	<input type="text"/>
Fourth Receiver	<input type="text"/>

Step2 Configure the Email parameter.

Parameter	Description
Enable E-Mail	Enable or Disable the Email function.
Authentication	Enable or Disable the server authentication feature.
SMTP Server	The SMTP Server IP address or host name.
SMTP Port	The SMTP port is usually set as 25. Some SMTP servers have their own port, such as 587 or 465.
Transport Layer Security	Transport Layer Security usually is None.  If you use Gmail, Transport Layer Security must be set to TLS or STARTTLS and SMTP Port must be set to 465 or 25 or 587, which port you choose should be decided by which Transport Layer Security you select.
SMTP Username	The user account of sender's Email for SMTP server authentication.
SMTP Password	The password of sender's Email for SMTP server authentication.
Sender	The Email address of sender.
First/Second /Third/Fourth Receiver	The Email address of user to be notified. you can set 4 receivers

Step3 Click **Save** button to take effect.

Step4 Click Test to see if Mail has been successfully configured.

If the test success, you can see the success information, at the same time the receivers will receive a test mail.

-----End

## FTP Settings

The system can be configured to send an picture to the FTP server if an alarm or motion event is detected etc..

Step1 Choose " (Parameter Configuration) > Local settings > FTP Settings". The **FTP Settings** page is displayed.



### FTP Settings

FTP Address	<input style="width: 90%;" type="text" value="ftp://172.16.1.69"/> <small>Example: ftp://192.168.1.103/NVR</small>
FTP Port	<input style="width: 90%;" type="text" value="21"/>
FTP Mode	<input style="width: 90%;" type="text" value="PASV"/>
FTP Username	<input style="width: 90%;" type="text" value="lhr"/>
FTP Password	<input style="width: 90%;" type="password" value="••••"/>

Step2 Configure the FTP parameter.

Parameter	Description
FTP Address	<ul style="list-style-type: none"> <li>If your FTP server is located on the LAN, you can set FTP address as ftp://IP address.(eg.ftp://192.168.1.103/dir).</li> <li>If your FTP server is located on the WAN, you can set FTP address as ftp://domain name/dir.(eg.ftp://test.no-ip.org/dir).</li> </ul>
FTP Port	Default port is 21. If changed, external FTP client program must change the server connection port accordingly.
FTP Mode	Here supports two modes: PORT and PASV.
FTP Username	The user account of FTP server.
FTP Password	The user password of FTP server.

Step3 Click **Save** button to take effect.

Step4 Click Test to see if FTP has been successfully configured.

If the test success, you can see the success information.

-----End

## DDNS

The FOSCAM NVR has embedded a unique DDNS domain name when producing, and you can directly use the domain name, you can also use the third party domain name.

Choose (Parameter Configuration) > Local settings > DDNS". The **DDNS** page is displayed.

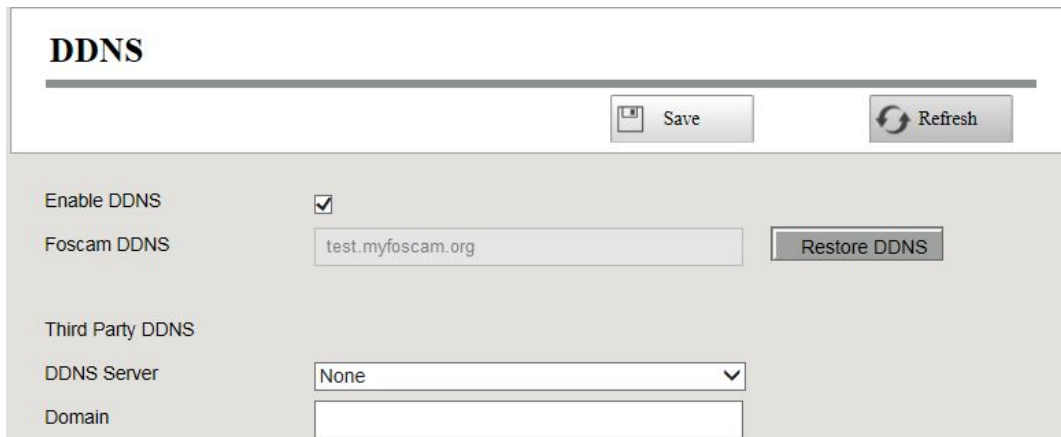

**DDNS**

Save Refresh

Enable DDNS

Foscam DDNS test.myfoscam.org Restore DDNS

Third Party DDNS

DDNS Server None

Domain



### Note

Here take *test.myfoscam.org* for example.

**Enable DDNS:** Check the DDNS checkbox to enable this feature.

Click Save button to take effect. Then you can use *http:// Domain name + HTTP Port* to access the NVR via internet.

**Third Party DDNS:** You can also use third part DDNS, such as *www.no-ip.com*, *www.3322.com*. If you set the third party DDNS, refer to the “Appendix II Common operations > 1.Third Party Domain Name Settings”.

## Video Encode



Choose “(Parameter Configuration) > Local settings > Video Encode”. The **Video Encode** page is displayed.

You can configure the encoding scheme parameters of the IP Camera, the NVR system will synchronize your IP camera with encoding scheme.

## Video Encode

Channel	Channel01
Stream	Main stream
Resolution	1920 X 1080
Bit Rate	4M
Frame Rate	30
Key Frame Interval	30

Parameter	Description
Channel	You can select the channel for the IP Cameras.
Stream	You can set the value of Resolution, Bit Rate, Frame Rate, Key Frame Interval when the video was set the main stream.
Resolution	The resolution of the IP Camera. The higher the resolution is, the sharper the video quality is, but also with the increasing stream, which will take up the higher bandwidth.
Bit Rate	Generally speaking, the larger the bit rate is, the clearer video will become. But the bit rate configuration should combine well with the network bandwidth. If the bandwidth is very narrow, and bit rate is large, that will lead to video can not play well.
Frame Rate	Note that a larger frame size takes up more bandwidth. <ul style="list-style-type: none"> <li>● When the video format is 50Hz, the maximum frame rate is 25 fps.</li> <li>● When the video format is 60Hz, the maximum frame rate is 30 fps.</li> </ul> You should choose a lower frame rate when the bandwidth is limited. Normally, when the frame rate above 15, you can achieve fluently video.
Key Frame Interval	The time between last key frame and next key frame. The shorter the duration, the more likely you will get a better video quality, but at the cost of higher network bandwidth consumption.

Click **save** button to take effect.

## System Log

Choose " (Parameter Configuration) > Local settings > System Log". The **System Log** page is displayed.

The operation, alarm, exception and information of the NVR can be stored in log files, which can be searched and viewed at any time.

The Log Type contains Alarm log, System log and Operation log.

### System Log

Channel	All channels		
Log Type	All logs		
Date	2014-6-20		
Start time	0	0	0
End time	23	59	59

NO.	Channel	Time	User	IP	System Log

### 【 Search Log 】

1. Select the Channel, Log Type, Date, Start time and End time.
2. Click the **Search** button to list all matched logs.

## 4.4.2 Device Management

### IP Camera Setup

NVR provide a function of auto searching IP camera. When there are supported IP cameras in the same network segment of a LAN with NVR, you may add it in one button with IP Camera's user name, password and port number.

### 【 Auto Adding IPC 】

Choose " (Parameter Configuration) > Device Management > IP Camera Setup". The

IP Camera Setup page is displayed.

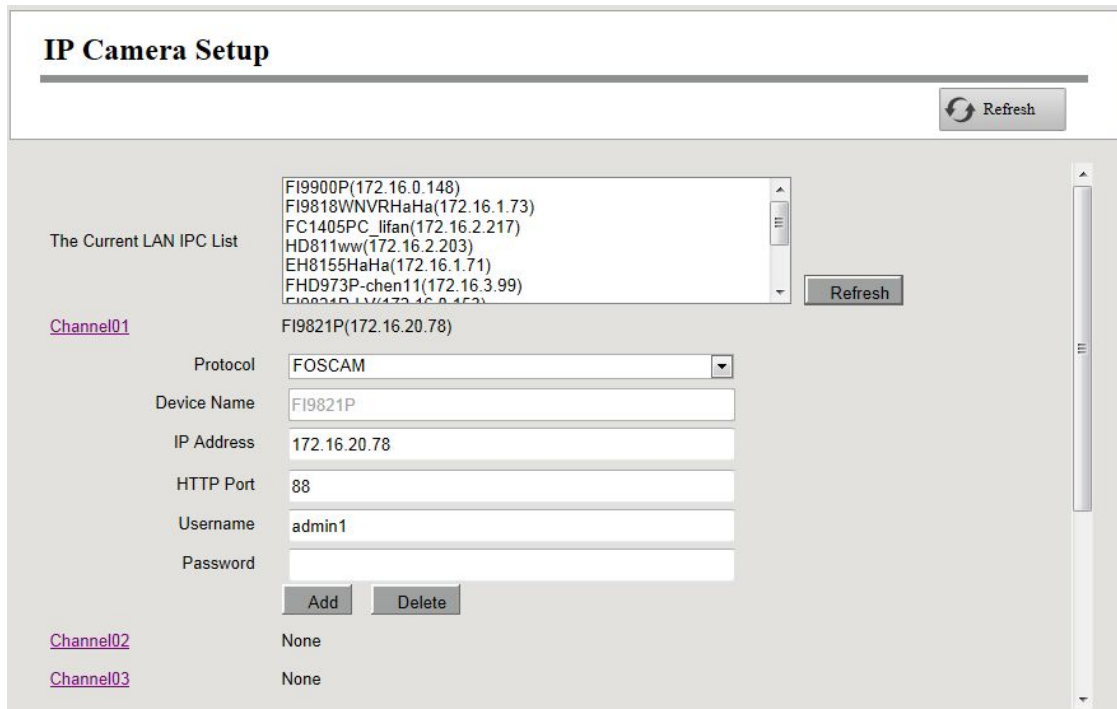

Step1 You can see all IP Cameras searched in The Current LAN IPC List.

Step2 Select one channel from Channels.

Step3 Choose the IP Camera in the list of 'The Current LAN IPC List' .

Choose the Protocol from the drop list. Input the Username and Password of the IPC.

Select the FOSCAM protocol for Foscam brand IPC, and select the ONVIF protocol for other brands IPC.

Step4 Click Add button to finish adding.

-----End

### 【 Manually Adding IPC 】

You can also manually add the IPC device. After select any one of the channels, input information of the IPC. Then click Add button to finish adding.

## Hard Disk Information

You can configure the Disk Saturation, Pre-recorded Time for HDD information.

Step1 Choose "  (Parameter Configuration) > Device Management > Hard Disk Information".  
The **Hard Disk Information** page is displayed.

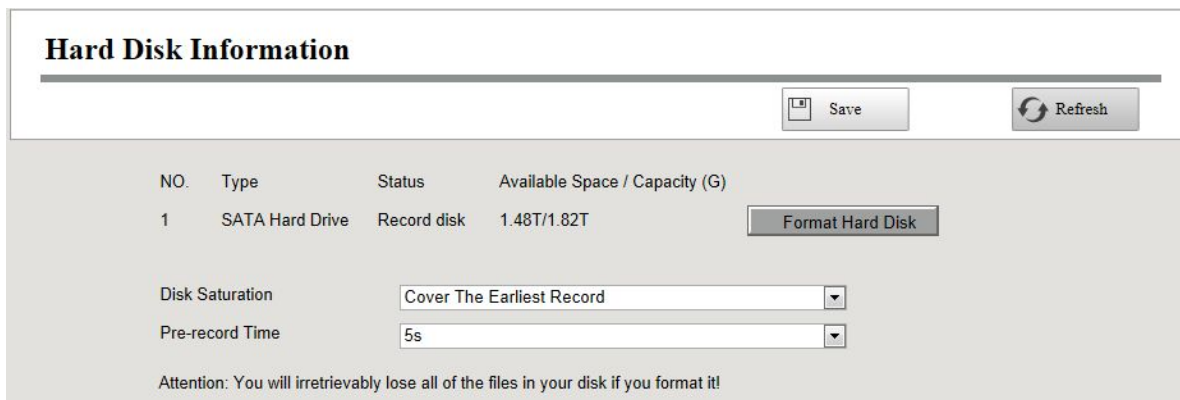

Step2 You can configure the following settings.

- Format Hard Disk: Click the **Format Hard Disk** button to initialize the SATA disk for recording.

Note: Initializing the HDD will erase all the data saved on it, please backup the data before formatting hard disk if necessary.

- Disk Saturation: When the disk is saturated, you can choose to stop recording or cycle coverage.
- Pre-record Time: The time you set to record before the event.  
For example, when an alarm triggered the recording at 11:00, if you set the pre-record time as 5 seconds, the camera records it at 10:59:55.

Step3 Click **Save** button to take effect.

-----End

## Storage Location

You can configure the storage location for snap picture and backup record file.

Choose “ (Parameter Configuration) > Device Management > Storage Location”. The **Storage Location** page is displayed.

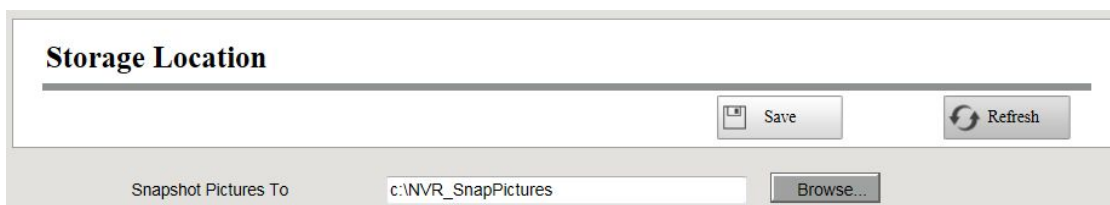



Snapshot Pictures To: Click the icon  (Take Snapshot) in the Real time Preview page or Playback page, the snapshot picture will be saved to the Snap Picture Path in the local computer.

## 4.4.3 Service Configuration

### Motion Detection

Follow the steps to set the motion detection parameters. In the live view mode, once a motion detection event takes place, the NVR can analyze it and perform many actions to handle it. Enable motion detection function can trigger certain channels to start recording, or trigger full screen monitoring, output alarm, send Email, upload FTP, buzzer alarm and so on.

In the live view mode, there are icons at the right bottom of the screen for each channel.

- The Icon  indicate alarm was triggered.
- The Icon  indicate the IPC is recording.

You can follow the steps to schedule a record which triggered by the detected motion.

Choose " (Parameter Configuration) > Service Configuration > Motion Detection". The **Motion Detection** page is displayed.

## Motion Detection

Save **7**      Refresh

Channel Channel02 **1**

Enable  **2**

Sensitivity Medium **3**

Detection Interval 10s

Action

Alarm Output   
 Send E-mail   
 FTP   
 Record       Record Time 30s **4**  
 Buzzer   
 IPC Audio Warning

Set Detection Area **5**

Detection Schedule **6**

All	00	01	02	03	04	05	06	07	08	09	10	11	12	13	14	15	16	17	18	19	20	21	22	23
MON																								
TUE																								
WED																								
THU																								
FRI																								
SAT																								
SUN																								

- Step1    Select channel from drop-down box list.
- Step2    Check the **Enable** checkbox to enable motion detection function.
- Step3    Select the **Sensitivity** and **Detection Interval**.  
 The higher the sensitivity, the NVR will be more easily alarmed.  
 The Detection Interval time between two motion detection.
- Step4    Check the checkbox to select the linkage method. You may refer to follow table for details of linkage methods.



Parameter	Description
Alarm output	<p>When the IO Alarm is triggered, you can choose whether to alarm via the alarm output device.</p> <p><b>Notes:</b></p> <p>FN3004H do not support Alarm output function.</p> <p>Make sure you have installed the alarm output device.</p>
Send E-Mail	<p>When the Motion detection is triggered, you can choose whether to send e-mail.</p> <p><b>Note:</b> Make sure you have set Email.</p>
FTP	<p>When the Motion detection is triggered, you can choose whether to upload detection picture to FTP server.</p> <p><b>Note:</b> Make sure you have set FTP.</p>
Record	<p>If you select this checkbox, when the Motion detection is triggered, the NVR will record automatically and store the record files to the HDD.</p>
Record Time	<p>When you check the <b>Record</b>, you need to configure motion detection recording time.</p>
Buzzer	<p>When the Motion detection is triggered, you can choose whether to enable buzzing sound of the NVR device.</p>
IPC Audio Warning	<p>If you select this checkbox, when the Motion detection is triggered, the people around the camera will hear beep alarm sound of the IPC.</p>

#### Step5 Set Detection Area

1. Click **Set Detection Area** button and it pop up a window.

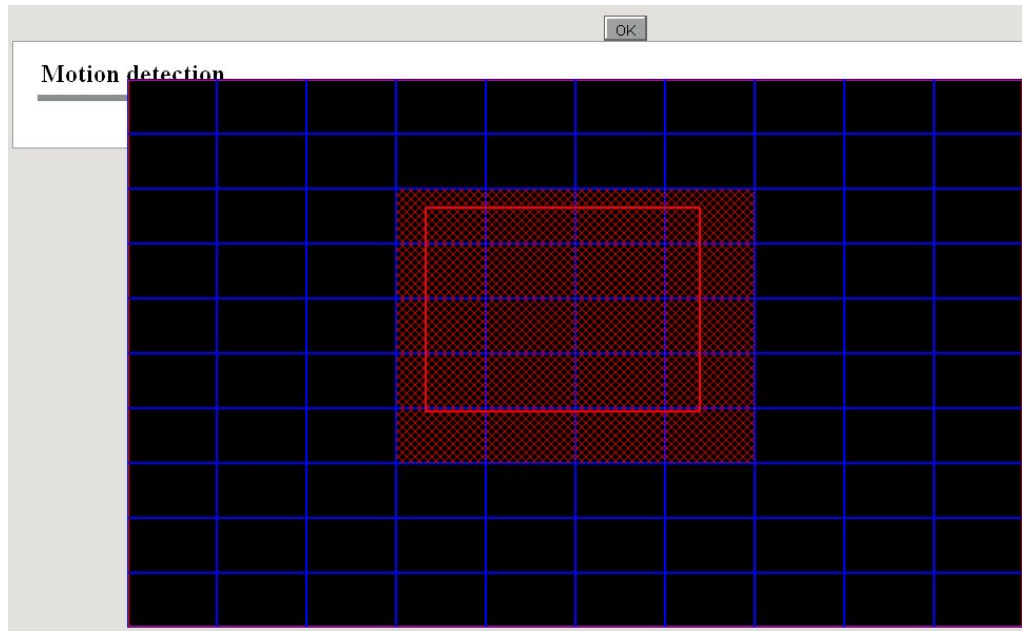

2. Drag and draw the area for motion detection by left mouse.

**Note:** To clear the motion detection area, Drag and draw the motion detection area by left mouse.

3. Click **OK** button to save and quit. When something moving in the detection area, the NVR will alarm.

**Step6 Set Detection Schedule**

Set up arming schedule of the channel for the motion detection.

You can choose a week, one day of a week, the certain time period for the motion detection alarm.

- Choose all Time Period

Click the black button up the MON, you will see all time range turn red. When something moving in the detection area at anytime, the NVR will alarm.

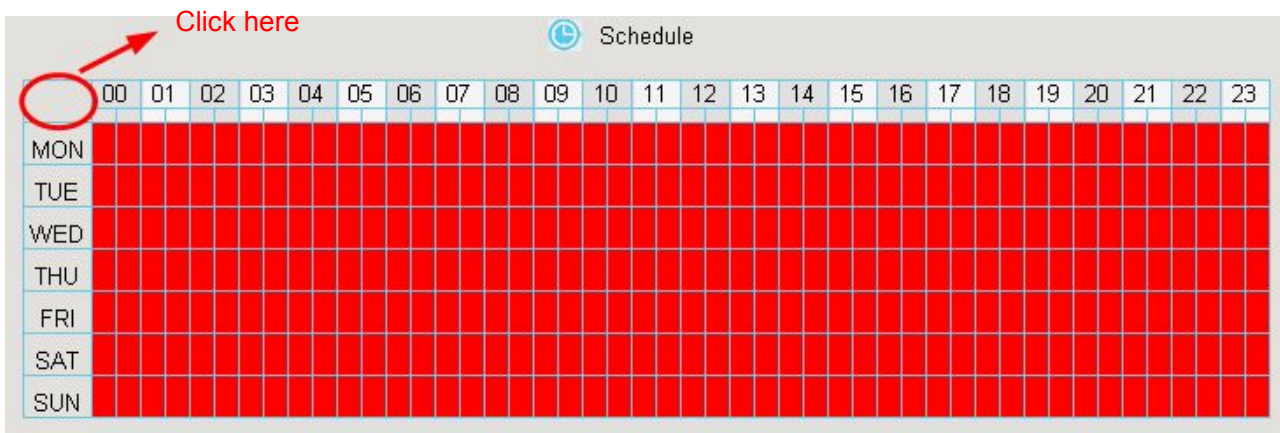

- Choose one day

Click the week day words, the corresponding column will be selected.

For example, click TUE, the all column of TUE turns to red, that means during Tuesday whole day, when something moving in the detection area, the camera will alarm.

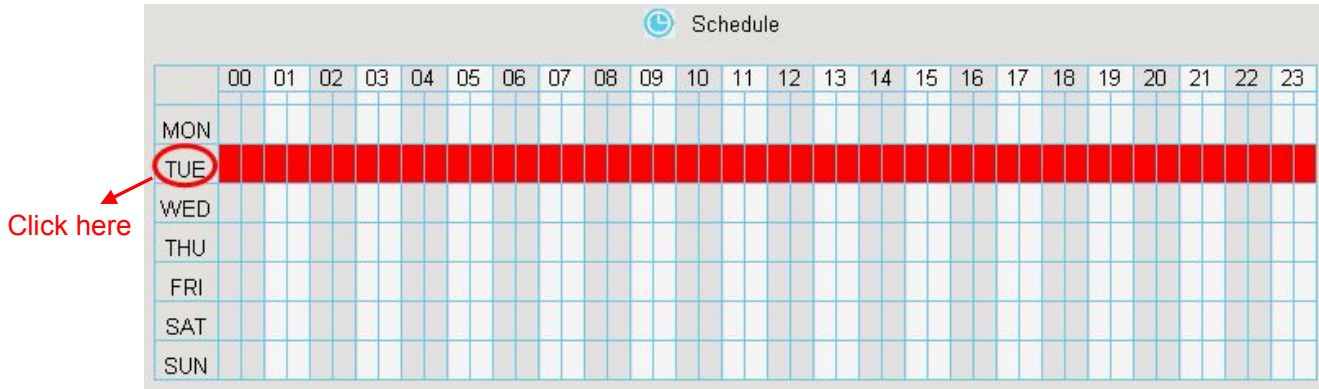

- Choose the Certain Time Period

Press the left mouse and drag it on the time boxes, you can select the serial area.

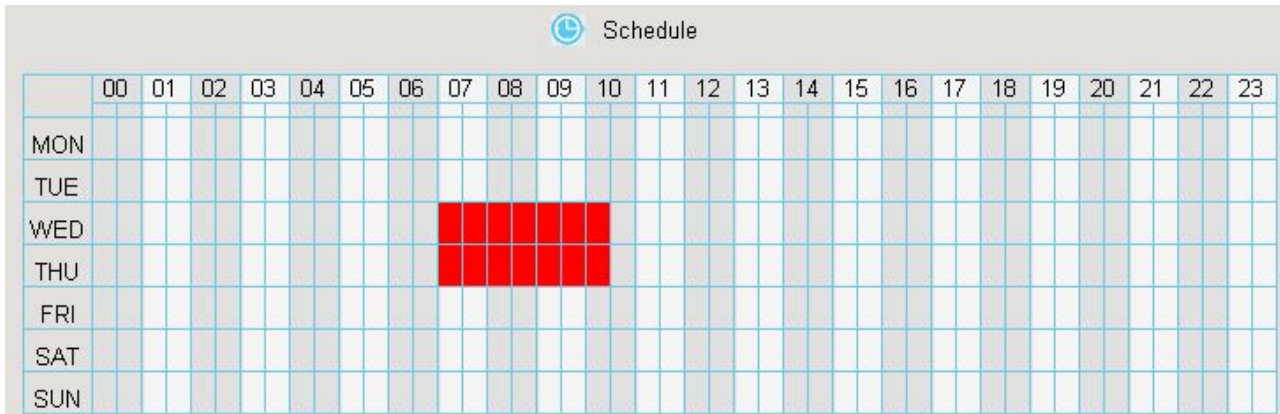

**Step7** Click Save button to take effect..

When the motion has been detected during the detection time in the detection area, the NVR will alarm and adopt the corresponding alarm linkage.

**Note:** You must set the detection area and detection schedule, or else there is no alarm anywhere and anytime.

-----End

## Schedule

You can enable or disable schedule record for the every channel.

Set the record schedule, and then the NVR automatically starts/stops recording according to the configured schedule. The recording files will be save to the HDD or mobile store device.

The Icon  indicate starts schedule recording at the right bottom of the screen for certain channel.

Step1 Choose " (Parameter Configuration) > Service Configuration > Schedule". The **Schedule** page is displayed.

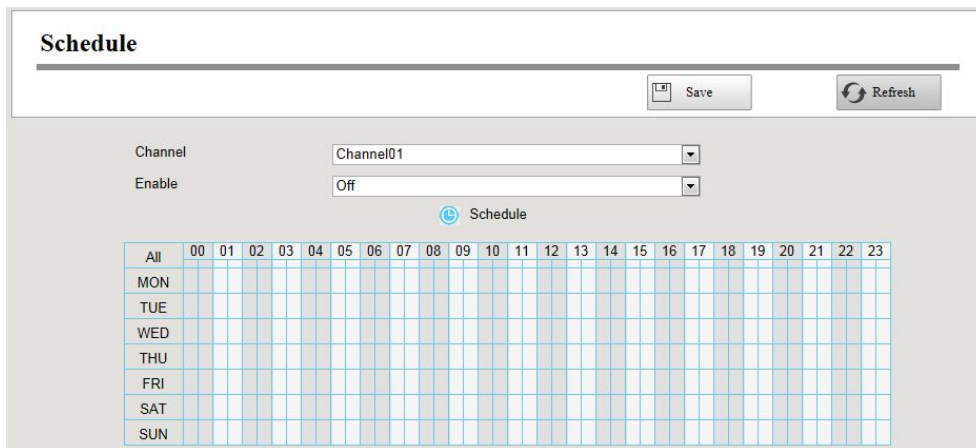

All	00	01	02	03	04	05	06	07	08	09	10	11	12	13	14	15	16	17	18	19	20	21	22	23
MON																								
TUE																								
WED																								
THU																								
FRI																								
SAT																								
SUN																								

Step2 Select channel from drop-down box list.

Step3 Select Open or Off for the **Enable** schedule record.

Step4 Set Recording schedule time of the channel.

You can choose a week, one day of a week, the certain time period for the recording.

For detailed procedure, please refer to Motion Detection.

Step5 Click **Save** button to take effect.

-----End



## External Alarm

**Note:**FN3004H do not support the External Alarm function.

External alarm input devices (such as door status sensor, infrared sensor, and smoke sensor) are connected through the alarm input interface and external alarm output devices (such as local audible alarm and visual alarm) are connected through the alarm output interface. After the devices are connected successfully, you can configure information about the external alarm devices. When an external alarm input device triggers an alarm, the NVR system transmits the alarm information to an external alarm output device, which

makes corresponding response.

In the live view mode, there are icons at the right bottom of the screen for each channel.

- The Icon  indicate alarm was triggered.
- The Icon  indicate the IPC is recording.

Step1 Choose " (Parameter Configuration) > Service Configuration > External Alarm". The **External Alarm** page is displayed.

**External Alarm**

Save Refresh

Alarm Input: 1

Enable:

Duration: 60s

Buzzer:

Send E-mail:

FTP:

Alarm Output:

Link Record Channel:  Channel01  Channel02  Channel03  Channel04  Channel05  Channel06  Channel07  Channel08  Channel09

Detection Schedule

All	00	01	02	03	04	05	06	07	08	09	10	11	12	13	14	15	16	17	18	19	20	21	22	23
MON																								
TUE																								
WED																								
THU																								
FRI																								

Step2 Select the **Alarm Input** interface from Alarm Input drop-down box list.

Step3 Check the **Enable** checkbox to enable IO Alarm function.

Step4 Set the Duration from drop-down box list.

Step6 Check the checkbox to select the linkage method. You may refer to follow table for details of linkage methods.

Parameter	Description
Buzzer	When the IO Alarm is triggered, you can choose whether to enable buzzing sound of the NVR device.
Send E-mail	When the IO Alarm is triggered, you can choose whether to send e-mail.  Note: Make sure you have set Email.
FTP	When the IO Alarm is triggered, you can choose whether to upload detection picture to FTP server.  Note: Make sure you have set FTP.
Alarm output	When the IO Alarm is triggered, you can choose whether to alarm via the alarm output device.  Note: Make sure you have installed the alarm output device.
Link Record Channel	Check the checkbox to start recording for the certain channel.

Step7 Set external alarm time time of the channel.

You can choose a week, one day of a week, the certain time period for the IO alarm.

For detailed procedure, please refer to “4.6.3 Service Configuration > Motion Detection”.

Step8 Click Save button to take effect.



-----End

## Other Alarm

Step1 Choose “ (Parameter Configuration) > Service Configuration > Other Alarm”,The **Other Alarm** page is displayed.

### Other Alarm

---

 Save
 Refresh

Type HDD Loss ▼

Buzzer

Step2 Select Type form drop-down box list.

Step3 Check the **Buzzer** checkbox if you want to enable buzzing sound of the NVR device.

Step4 Click **Save** button to take effect.

-----End

## OSD

You can configure the OSD (On screen Display) information of the NVR.

Step1 Choose "  (Parameter Configuration) > Service Configuration > OSD", The **OSD** page is displayed.

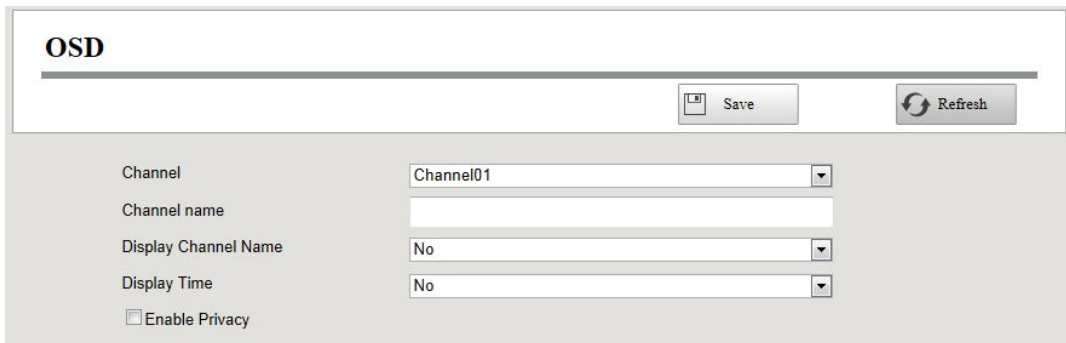

Step2 You can configure the follow parameters.

Parameter	Description
Channel	You can select one channel from drop-down box list..
Channel name	You can modify the IP Camera's name. After you modify the name and save the modification, the NVR system synchronizes the channel name to the corresponding IPC device name. The channel name will be shown on the top left of the video image.
Display Channel Name	There are two options: Yes or No. Select Yes and you can see the IP camera's name on the video
Display Time	There are two options: Yes or NO. Select Yes and you can see the system date on the channel video.

Step3 You can configure the privacy zone settings for the camera. Check the **Enable Privacy** checkbox and it pop up a window. If the IPC device type is MJ or IPC protocol type is ONVIF,

the feature is invalid.

**Step4** You can use the mouse to click and drag the text frame on the live view window to adjust the OSD position.

**Step5** Click **Save** button to finish the mask area setting. The mask area will be marked with black.

-----End

## Pan & Tilt Speed

If the IP Camera has the PTZ function, you can configure the pan and tilt speed of the IP Camera.

**Step1** Choose "  (Parameter Configuration) > Service Configuration > Pan & Tilt Speed". The **Pan & Tilt Speed** page is displayed.

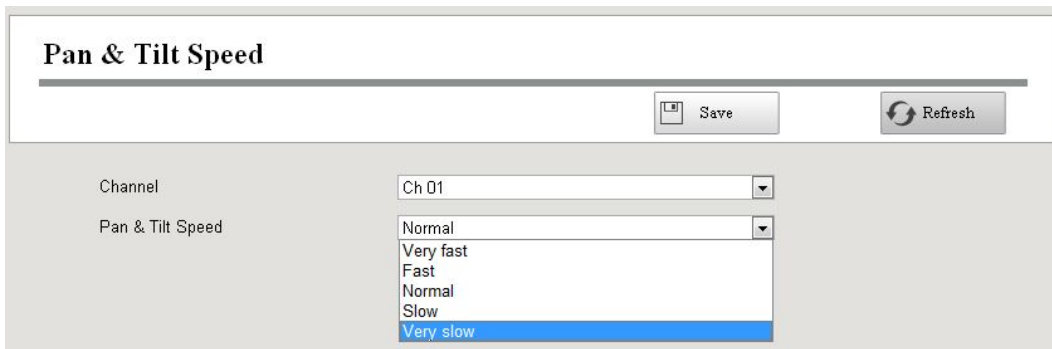

**Step2** Select channel from drop-down box list.

**Step3** Select **Pan & Tilt Speed** from drop-down box list.

There are five PT speed types: very fast, fast, normal, slow and very slow.

**Step6** Click **Save** button to take effect.

-----End

## Cruise Settings

If the IP Camera has the PTZ function, you can manage the cruise of the IP camera.

Choose "  (Parameter Configuration) > Service Configuration > Cruise Settings". The **Cruise Settings** page is displayed.

There are two default cruise tracks: Vertical and Horizontal.

- Vertical: The IP Camera will rotate from up to down
- Horizontal: The IP Camera will rotate form left to right.



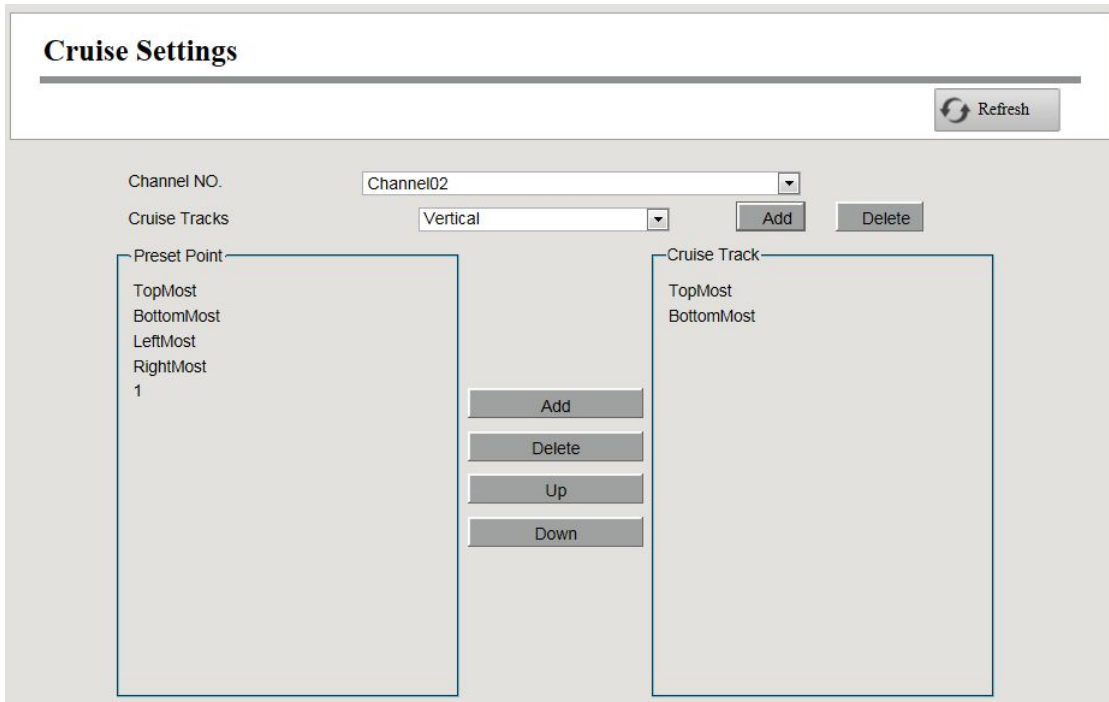

**【Add Cruise Track】**

1. Select channel from drop-down box list.
2. Click **Add** button and enter a descriptive name to identify the cruise track.
3. On the lower left of the page, you can see all preset points you have added. Select one preset point and click **Add** button, you can see the preset point has been added to the cruise track on the cruise track page. You need to add two or more preset points to the cruise track.

How to customize the preset, please refer to “4.3 Live Video > Preset settings”.

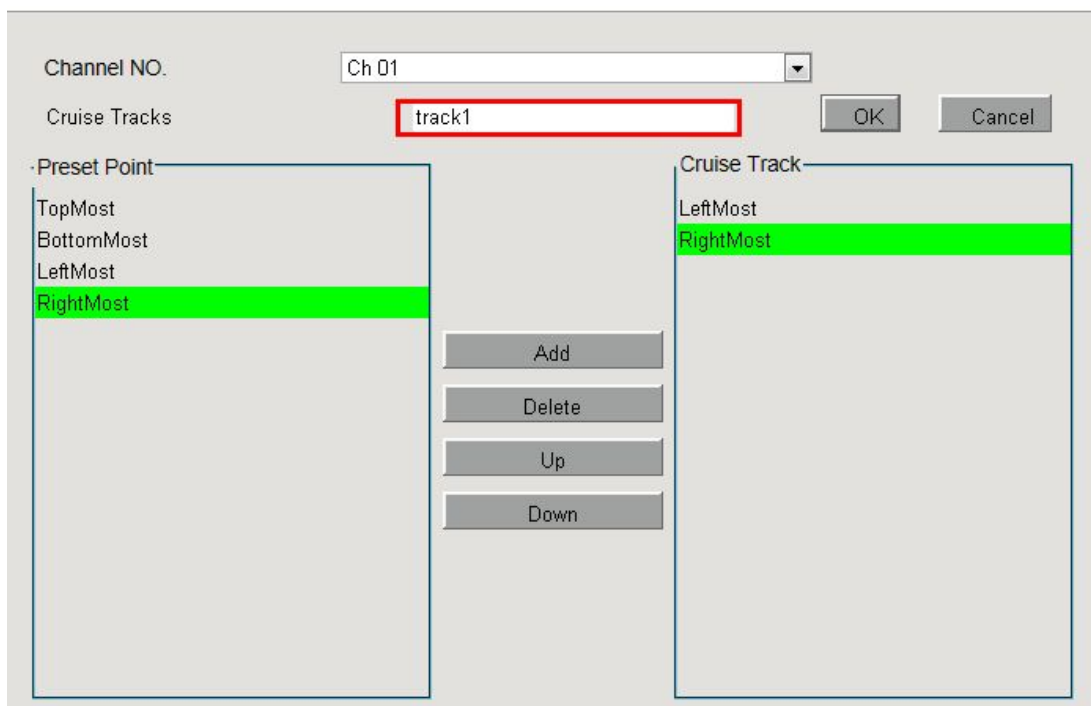

There are other buttons between the Preset points and Cruise track, you can use these buttons to adjust the order of preset points or add/delete one preset points in one cruise track.

**Add:** Select one preset points and add it to the selected cruise track.

**Delete:** Select one preset points you have added to one cruise track, click delete.

**Move up/ down:** Select one cruise track, adjust the order of preset points in one cruise track.

4. Click **OK** button and the cruise track will take effect.

You can add other cruise track as the same method.

After add the cruise track, back to the surveillance window of IP Camera, select **Cruise**, here you can see all cruise tracks you have added.

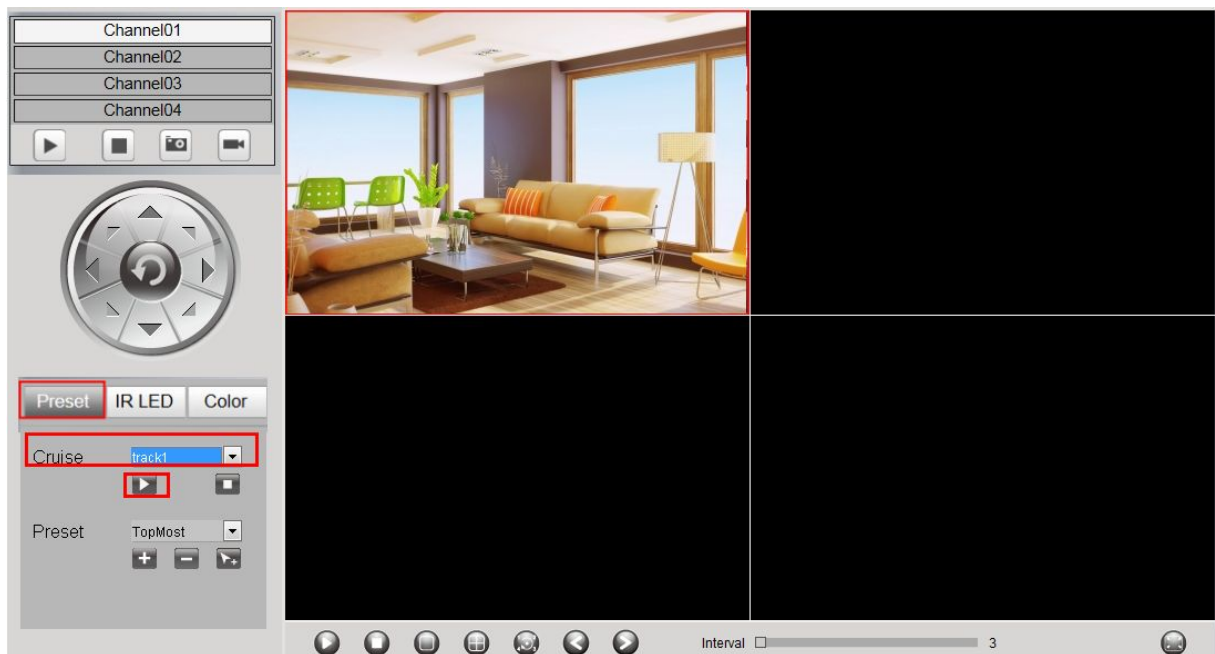

### 【Query Cruise Track】

1. Select channel from drop-down box list.
2. Select the track from the Cruise Tracks.

You can see the cruise track which you want to query.

### 【Delete Cruise Track】

1. Select channel from drop-down box list.
2. Select the track from the Cruise Tracks.
3. Click **Delete** button to delete the cruise track.

You can see the cruise track which you want to query.

**Note:**The default cruise track can't be deleted.

## 4.4.4 User Management

### User Account

User levels by permission from low to high are visitor, operator, administrator. Different user levels have different operating permission. The default user name of device administrator is admin with no password.

The administrator has the permission to add and delete all users and configure user parameters.

You can add, modify, delete username/password or distribute authority for users.

The valid value range of Username and Password is 1 ~ 20 characters, it contains the English letter, numeric and symbol.

Choose " (Parameter Configuration) > User Management > User Account". The **User Accounts** page is displayed.

### User Accounts

NO.	Username	Password	Competence	Enable
1	<input type="text" value="admin"/>	<input type="password" value="..."/>	Administrator	<input checked="" type="checkbox"/>
2	<input type="text"/>	<input type="password"/>	visitor	<input type="checkbox"/>
3	<input type="text"/>	<input type="password"/>	visitor	<input type="checkbox"/>
4	<input type="text"/>	<input type="password"/>	visitor	<input type="checkbox"/>
5	<input type="text"/>	<input type="password"/>	visitor	<input type="checkbox"/>
6	<input type="text"/>	<input type="password"/>	visitor	<input type="checkbox"/>
7	<input type="text"/>	<input type="password"/>	visitor	<input type="checkbox"/>
8	<input type="text"/>	<input type="password"/>	visitor	<input type="checkbox"/>

#### 【 Add a User 】

1. input the Username and Password.
2. Select the user level from the **Competence**.
3. Check the **Enable** checkbox.
4. Click **Save** button to save the settings and the added new user will be displayed on the list.

#### 【 Changing Password of Admin 】

1. In the **Password** text field, delete the old password, input the new password.
2. Click **Save** button to take effect.

## 4.4.5 System Management

### Import/Export Configurations

You can import or export a configuration file for NVR system.

Choose " (Parameter Configuration) > System Management > Import/Export Configuration". The **Import/Export Configurations** page is displayed.

### Import/Export Configurations

Backup is used to save your current settings. It is recommended to backup your configuration before modifying or upgrading firmware.

Settings can be restored by uploading the backup file.

Path:

Note:

1. All current settings will be overwritten when importing a configuration file. If a bad configuration file is uploaded the camera may not work.
2. Do not disturb the update process by turning off the power, the IP camera may be damaged. The loading process takes about 50 seconds, the camera will reboot automatically.

- **Backup Configurations:** Backup is used to save your current settings. It is recommended to backup your configuration before modifying or upgrading firmware. Click **Backup** button and the configuration files of the NVR will be exported for backup. The name of the configuration file name is config.bin.
- **Import:** Click "Browse...", select the config.bin file from the USB-flash disk and click the **Import** button. The loading process takes about 50 seconds, After having finished the import of configuration files, the NVR device will reboot automatically.



#### Note

- Do not disturb the update process by turning off the power.
- All current settings will be overwritten when importing a configuration file. If a bad configuration file is uploaded the NVR may not work.

## Upgrade

Choose "  (Parameter Configuration) > System Management > Upgrade". The **Upgrade** page is displayed.

Click **Browse** to select the upgrade file in the local directory.

Click **Upgrade** to start upgrade.

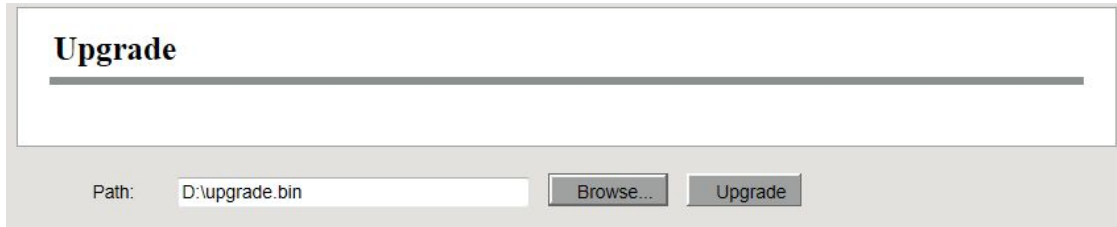

Upgrade

Path:

Don't shut down the power during upgrade. After upgrading, you can see the upgrade result.

Your current system version will be displayed on your screen. You may go to the "Parameter Configuration > Local Settings > Firmware Version" Page to check for the latest system versions available.

## Patch Installation

Choose "  (Parameter Configuration) > System Management > Patch Installation". The **Patch Installation** page is displayed.

You can install or install patch of the NVR.

Click **Browse** to select the patch file in the local directory.

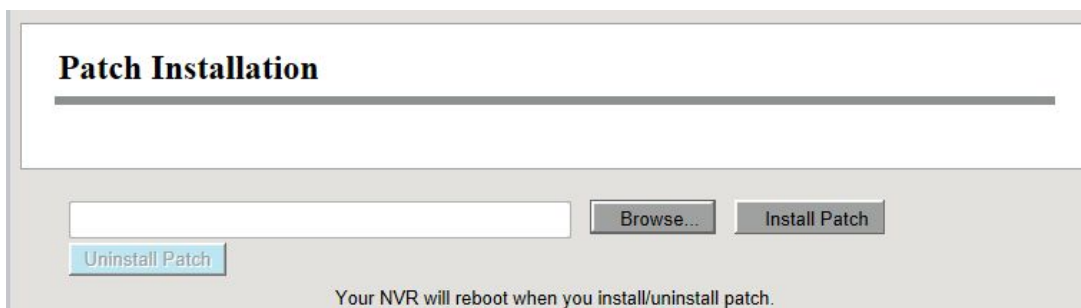

Patch Installation

Your NVR will reboot when you install/uninstall patch.

## Factory Reset

Choose " (Parameter Configuration) > System Management > Factory Reset". The **Factory Reset** page is displayed.

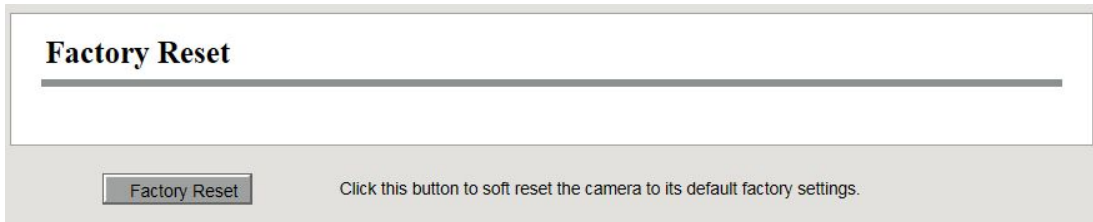

Click **Factory Reset** button, then click **OK** button in the pop-up message box and all parameters will return to factory settings. The NVR device will reboot automatically.

## Reboot

Choose " (Parameter Configuration) > System Management > Reboot". The **Reboot** page is displayed.

Click **Reboot** button, then click **OK** button in the pop-up message box. The NVR system will reboot.

## Auto Restore

Choose " (Parameter Configuration) > System Management > Auto Restore". The **Auto Restore** page is displayed.

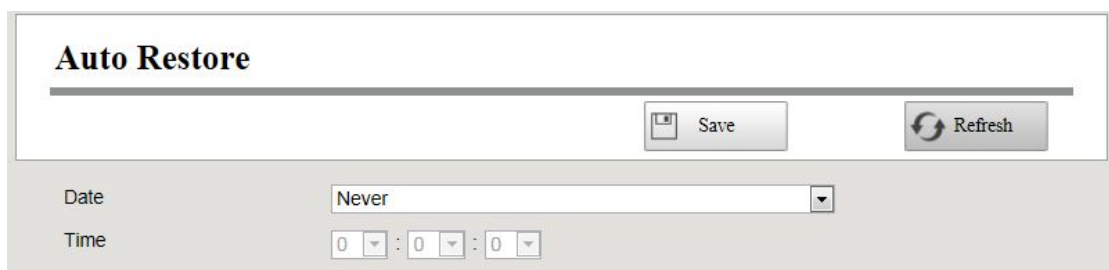



You can configure the Date and Time. The NVR system will be maintained at the setting time.





## 4.5 Playback

Choose “ (Playback)”, you can play the recording file of the NVR.





- 1: Select a date with recording in calendar.
- 2: Select the **Record Type**, and check the checkbox from the **Channels**.
- 3: Click **Search** button to search the matched recorded files. If there are search results, then they will be shown in the time bar area.
- 4: Manage the recording.

Icon	Description
	Start
	Stop
	Fast backward. The fast backward speed can be 4 times, 8 times, 16 times or 32 times of the normal playing speed. Click this button. The multiple of normal playing speed is displayed in the upper right corner of the playback page. For example, “<< X4” indicates the current fast backward speed is four times of the normal speed.

	<p>Fast forward. The fast forward speed can be twice, 4 times, 8 times, 16 times or 32 times of the normal playing speed. Click this button. The multiple of normal playing speed is displayed in the upper right corner of the playback page. For example, "&gt;&gt; X2" indicates the current playing speed is twice of the normal speed.</p>
	<p>Slow progress. The slow progress speed can be 1/2 times, 1/4 times, 1/8 times, 1/16 times or 1/32 times of the normal playing speed. Click this button. The multiple of normal playing speed is displayed in the upper right corner of the playback page. For example, "&gt;&gt; X1/2" indicates the current playing speed is 1/2 times of the normal speed.</p>
	<p>Download. Downloaded files are stored to the local PC.</p>
	<p>Select the channel, click this button, and you can take a picture of a corresponding channel to the local computer. You can set the storage path, refer to the "Web &gt; Parameter configuration &gt; Settings &gt; Storage Location".</p>
	<p>Full screen. Make the playing video maximized. After the video is maximized, press ESC to exit full screen.</p>

#### 4: Playback time

You can move the mouse to a specific time axis and click to watch the playback.

Icon	Description
	<p>Zoom-in time axis.</p>
	<p>Zoom-out time axis.</p>



# 5 Appendix

## 5.1 HDD Capacity Calculation

This chapter describes how to determine the size of the HDD you need when you install the NVR for the first time.

The NVR adopts the MPEG4/H.264 compression technology and its dynamic range is large. Therefore, the capacity of the HDD depends on the estimated size of files generated in each channel every hour according to code streams.

Computational formula of HDD Capacity:

Whole HDD Capacity(M)= number of the channels × time in need (hour) × spent of HDD Capacity per hour (MB/hour)

The meanings of parameters are as follows:

- Number of the channels: Number of channels where you need to enable recording.
- Time in need (hour): Time you need to record.
- Spent of HDD Capacity per hour

$$\text{Spent of HDD Capacity per hour(M/hour)} = \frac{\text{BitRate}}{8\text{bit}} * 3600(\text{sec ond})$$

You can obtain the **Bit Rate** by using the following methods:

- In the GUI interface, choose “Menu > Settings > Video” , view the value of the **Bit Rate**.
- In the Web interface, choose”Parameter Configuration > Local settings > Encoding Scheme”, view the value of the **Bit Rate**.

### 【Example】

If you select 4M for the bit rate and select four channels for recording and one week of recording is needed, you can calculate the HDD capacity by using the following formula:

Recording time ( hour ) =7days\*24 hours=168 hour

$$\text{Spent of HDD Capacity per hour(M/hour)} = \frac{4\text{Mbit}}{8\text{bit}} * 3600 = 1800\text{M/hour}$$

$$\text{Whole HDD Capacity(M)} = 4 * 168(\text{hour}) * 1800 \text{ (M/hour)} = 1209600\text{M},$$

$$1209600\text{M} = \frac{1209600\text{M}}{1024} = 1181.25\text{G}$$

According to the preceding calculation result, you are advised to buy a HDD of 1.5 TB or above.

## 5.2 Common operations

### 1.Third Party Domain Name Settings

User can also use third part DDNS, such as [www.no-ip.com](http://www.no-ip.com), [www.3322.com](http://www.3322.com)

Here take [www.no-ip.com](http://www.no-ip.com) for example:

① Step 1, Go to the website [www.no-ip.com](http://www.no-ip.com) to create a free hostname

Firstly: Login on [www.no-ip.com](http://www.no-ip.com) and click No-IP Free to register.

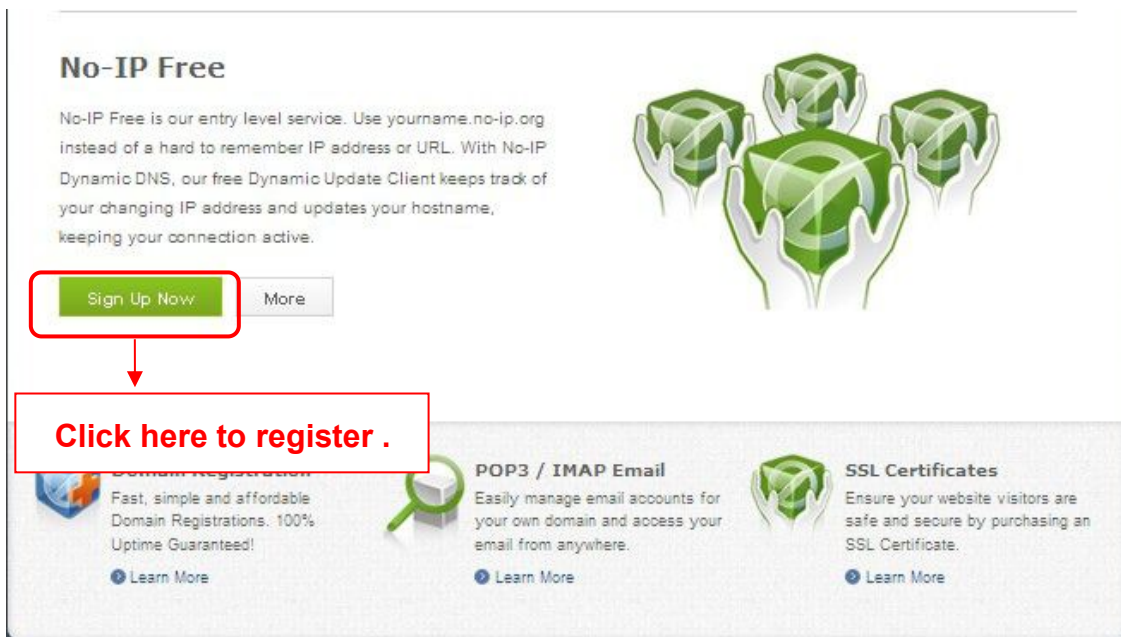
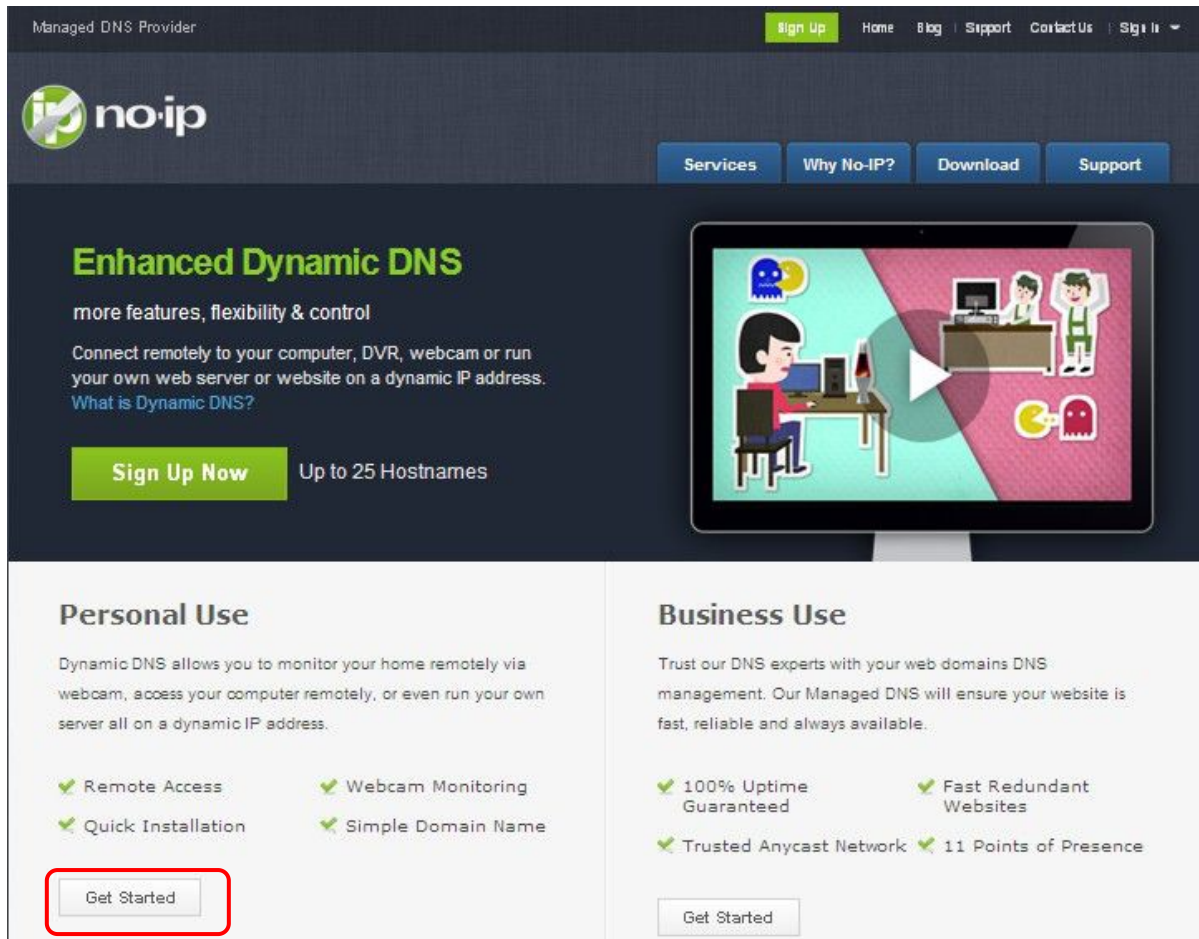

Figure 4.27

Please register an account step by step according to instructions on [www.no-ip.com](http://www.no-ip.com).

After registration, please login your email which used to register. You will receive an email from website,

please click the link to activate your ACCOUNT as indicated in email.

Secondly: Login the link with the registered username and password to create your domain name.

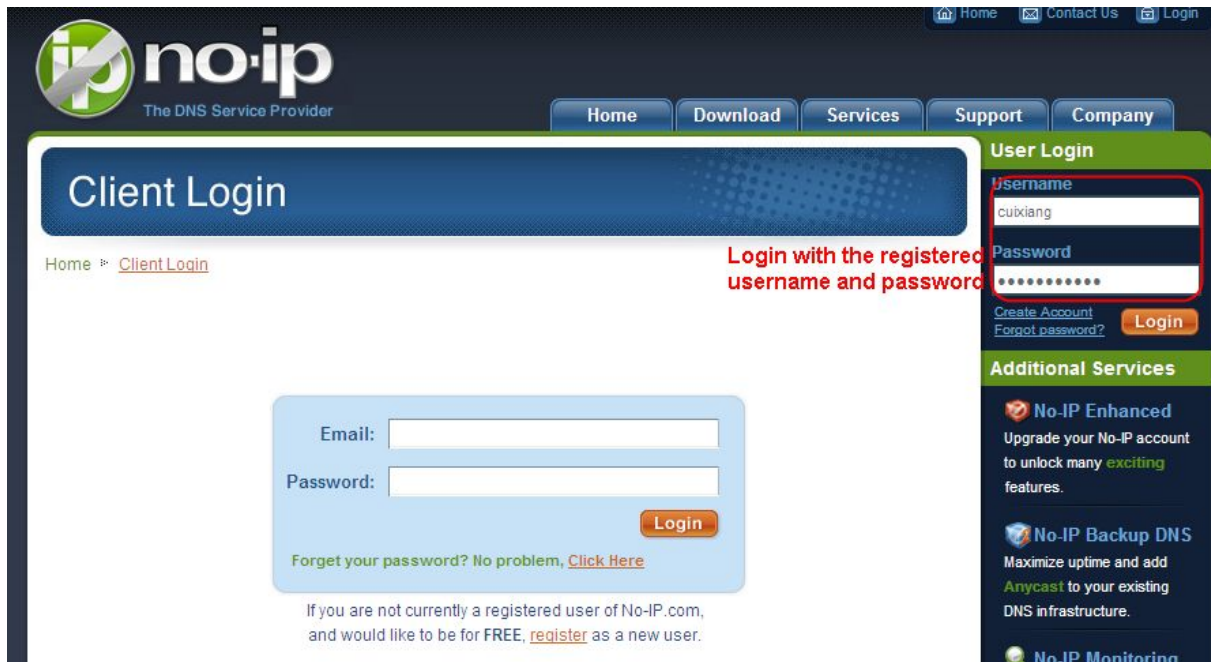
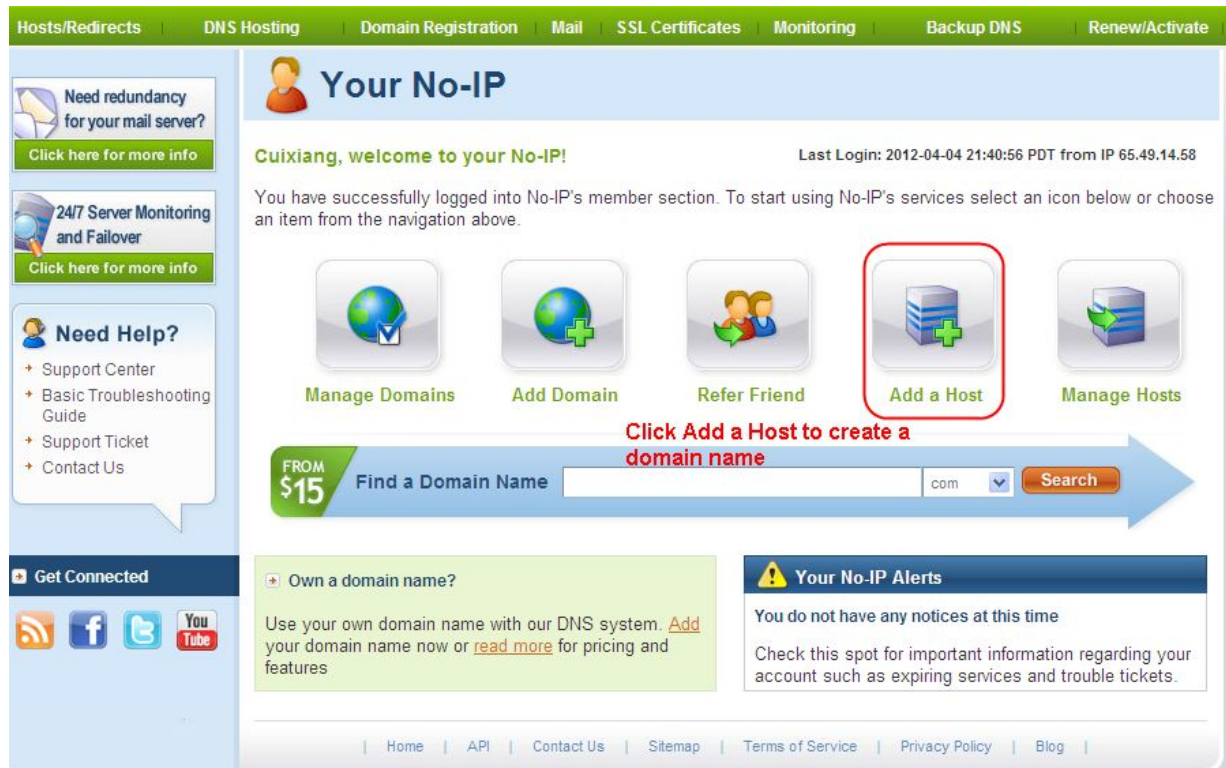

Figure 4.28



Please create the domain name step by step according to instructions on [www.no-ip.com](http://www.no-ip.com)

Step 2, DO DDNS Service Settings within the NVR

Please set DDNS Settings within the NVR by hostname, a user name and password you've got from [www.no-ip.com](http://www.no-ip.com)

Take hostname ycxgwp.no-ip.info, user name foscaml, password foscaml2012 for example.

Firstly, goes to option of DDNS Settings on the administrator panel.

Secondly, select No-Ip as a server..

Thirdly, fill foscaml as DDNS user, fill password foscaml2012 as DDNS password, fill ycxgwp.no-ip.info as DDNS domain and server URL, Then click save to make effect. The camera will restart and to take the DDNS settings effective.

Fourthly, after the restart, login the NVR, and go to option of Device Status on the administrator panel, and check if the DDNS status is successful.

If failed, please double check if you have input the correct hostname, user name, and password, and try to redo the settings.

**NOTE :**

If you have set Third Party DDNS successfully ,the Foscam Domain Name will be invalid. The Third Party DDNS and the Foscam Domain Name cannot work at the same time, the last time you configured will take effect.

② Do port forwarding within the router

Example: The camera's LAN IP address is <http://192.168.8.100:2000> , Media port no. is 9200.

Firstly, login the router, goes to the menu of Port Forwarding or Port Trigger (or named Virtue Server on some brands of router). Take Linksys brand router as an example, Login the router, and goes to Applications & Gaming->Single Port Forwarding.

Secondly, Create a new column by LAN IP address & HTTP Port No. of the NVR within the router showed as below.



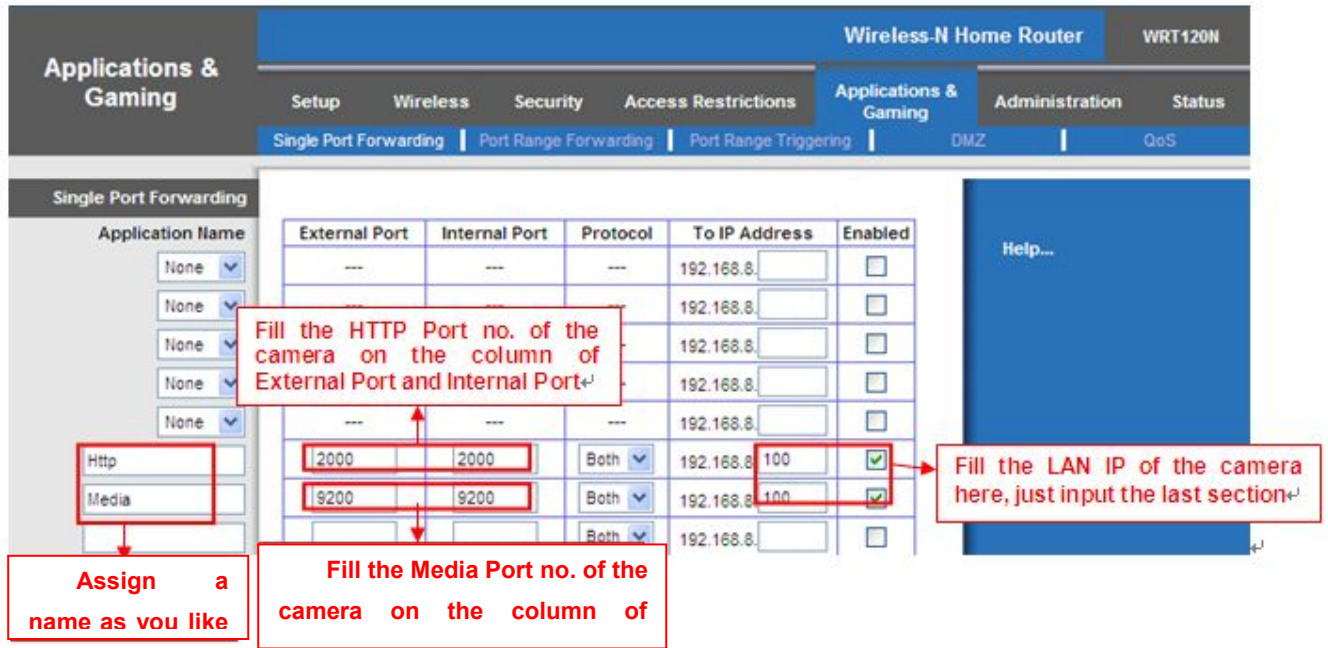

③ Use domain name to access the camera via internet

After the port forwarding is finished, you can use the domain name+ http no.to access the camera via internet. Take hostname ycxgwp.no-ip.info and http no. 2000 for example, the accessing link of the camera via internet would be [http:// ycxgwp.no-ip.info:2000](http://ycxgwp.no-ip.info:2000)

## 2. Configure the IP Parameters

Here we take TP-LINK router as an example.

- The IP address of the NVR must be in the range of the router address pool. Log in to the router client through the browser and select “DHCP server > DHCP service”. On the DHCP page, you can view the start address and end address of the address pool.

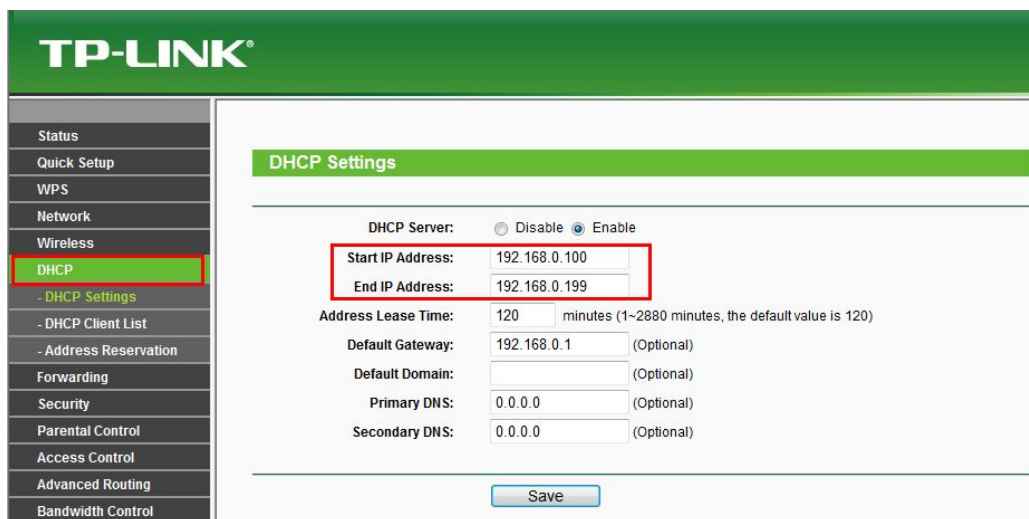

- The subnet mask of the NVR must be the same as the subnet mask in LAN port status. The default gateway of the NVR is the same as the IP address in LAN port status. The primary DNS and secondary DNS can be the same as the DNS in WAN port status.

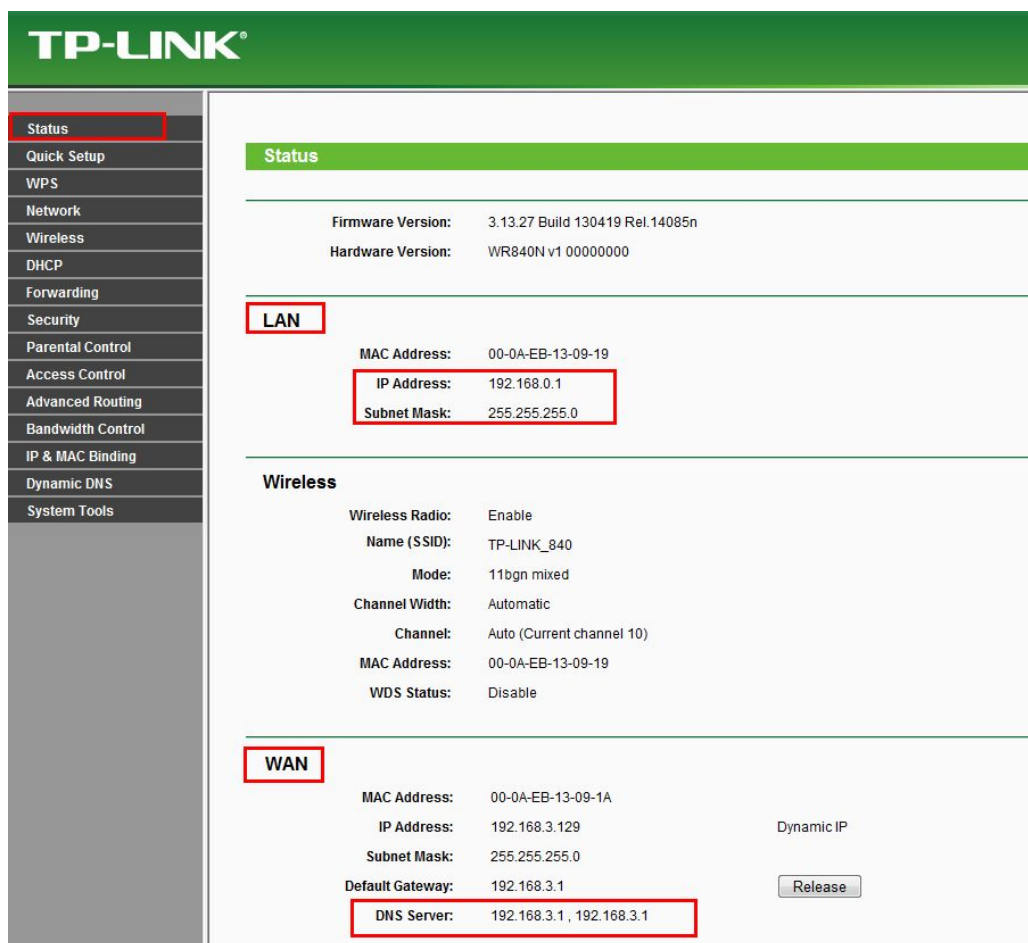

## 5.3 Specifications

ITEMS		FN3004H
Video Input	IP Video Input	4-ch 720P/960P HD IP Camera
	Capitable Camera	Foscam HD IP Cameras and other brand ONVIF-embedded cameras supported Foscam MJPEG cameras to be added by firmware upgrade
Video Output	Decoding Resolution	(1080P)1920 x 1080, (960P)1280 x 960, 720P(1280 x 720), VGA(640 x 480), VGA(640 x 360), QVGA(320 x 240), QVGA(320 x 180)
	Playback Resolution	(1080P)1920 x 1080, (960P)1280 x 960, 720P(1280 x

		720), VGA(640 x 480), VGA(640 x 360), QVGA(320 x 240), QVGA(320 x 180)
	Synchronous Playback	up to 4-ch 960P
	HDMI/VGA Output	1-ch, resolution: 1920 × 1080 /60Hz, 1280 × 720 /60Hz, 1440 × 900 /60Hz, 1024 × 768 /60Hz
<b>Hard Disk</b>	Type	USB External HDD
<b>External Interface</b>	Network	One 10/100/1000 Mbps RJ45 port
	USB	Two USB port for mouse and external storage
	Video Output	One HDMI, and one VGA
	Power Input	One DC power supply jack
	Button	one recovery button
	Alarm in/out	4-ch alarm in and 1-ch alarm out
<b>Software Features</b>	Control Method	Mouse
	Display Switch	1-ch/4-ch display switch
	Video Storage	Schedule Recording
	Video Playback	4-ch 720P synchronous video playback
	PTZ	Supports Pan/Tilt/Zoom control
	Camera Search/Management	Search camera in LAN, add camera, and manage a camera list
	Camera Settings	Network, video, display, alarm settings
	Disk Management	Set the video coverage strategy, format disk
	Motion Detection	Alarm area and schedule settings
	User Accounts	User account management
<b>System Requirements</b>	Operating System	Microsoft Windows XP, 7, 8;
	Browser	Microsoft IE8 and above version or compatible browser
<b>Power</b>	Power Supply	DC 5V/2.0A
<b>Physical</b>	Dimension(LxWxH)	89(L)*89(W)*31.5(H) mm
<b>Environment</b>	Operating Temperature	-20° ~ 55°C (-4°F ~ 131°F)
	Operating Humidity	20% ~ 85% non-condensing
	Storage Temperature	-20°C ~ 60° (-4°F ~ 140°F)
	Storage Humidity	0% ~ 90% non-condensing
<b>Certification</b>	CE, FCC, RoHS	
<b>Warranty</b>	Limited 2-year warranty	



ITEMS		FN3104H
<b>Video Input</b>	IP Video Input	4-ch 720P/960P HD IP Camera
	Capitable Camera	Foscam HD IP Cameras and other brand ONVIF-embedded cameras supported Foscam MJPEG cameras to be added by firmware upgrade
<b>Video Output</b>	Decoding Resolution	(1080P)1920 x 1080, (960P)1280 x 960, 720P(1280 x 720), VGA(640 x 480), VGA(640 x 360), QVGA(320 x 240), QVGA(320 x 180)
	Playback Resolution	(1080P)1920 x 1080, (960P)1280 x 960, 720P(1280 x 720), VGA(640 x 480), VGA(640 x 360), QVGA(320 x 240), QVGA(320 x 180)
	Synchronous Playback	up to 4-ch 960P
	HDMI/VGA Output	1-ch, resolution: 1920 × 1080 /60Hz, 1280 × 720 /60Hz, 1440 × 900 /60Hz, 1024 × 768 /60Hz
<b>Hard Disk</b>	Type	One SATA interface for one 3.5 inch disk
	Capacity	Up to 4TB, compatible with Seagate, Western Digital hard disk
<b>External Interface</b>	Network	One 10/100/1000 Mbps RJ45 port
	USB	Two USB port for mouse and external storage
	Video Output	One HDMI, and one VGA
	Power Input	One DC power supply jack
	Button	One power on/off button, and one recovery button
	Alarm in/out	4-ch alarm in and 1-ch alarm out
<b>Software Features</b>	Control Method	Mouse/remote controller/Internet Browser, on CMS and smart phone in coming
	Display Switch	1-ch/4-ch display switch
	Video Storage	Schedule Recording, Alarm Recording
	Video Playback	4-ch 720P synchronous video playback
	PTZ	Supports Pan/Tilt/Zoom control
	Camera Search/Management	Search camera in LAN, add camera, and manage a camera list
	Camera Settings	Network, video, display, alarm settings
	Disk Management	Set the video coverage strategy, format disk

	Motion Detection	Alarm area and schedule settings
	User Accounts	User account management
<b>System Requirements</b>	Operating System	Microsoft Windows XP, 7, 8
	Browser	Microsoft IE8 and above version or compatible browser;
<b>Power</b>	Power Supply	DC 12V/3.0A
<b>Physical</b>	Dimension(LxWxH)	220(L)*188.5(W)*39(H) mm
<b>Environment</b>	Operating Temperature	-20° ~ 55°C (-4°F ~ 131°F)
	Operating Humidity	20% ~ 85% non-condensing
	Storage Temperature	-20°C ~ 60° (-4°F ~ 140°F)
	Storage Humidity	0% ~ 90% non-condensing
<b>Certification</b>	CE, FCC, RoHS	
<b>Warranty</b>	Limited 2-year warranty	

ITEMS		FN3109H
<b>Video Input</b>	IP Video Input	9-ch HD IP camera input
	Capitable Camera	Foscam H.264 / MJPEG IP Cameras and other brand ONVIF cameras supported
<b>Video Output</b>	Decoding Resolution	1080P(1920 x 720),960P(1280 x 960), 720P(1280 x 720), VGA(640 x 480), VGA(640 x 360), QVGA(320 x 240), QVGA(320 x 180)
	HDMI Output	1-ch, resolution: 1920 × 1080 /60Hz, 1280 × 720 /60Hz,1440 × 900 /60Hz,1024 × 768 /60Hz
	VGA Output	1-ch, resolution: 1920 × 1080 /60Hz, 1280 × 720 /60Hz,1440 × 900 /60Hz,1024 × 768 /60Hz
<b>HDD</b>	HDD Type	One SATA interface for one 3.5 inch disk
	Capacity	Up to 4TB Digital hard disk
<b>External Interface</b>	Network	One 10/100 Mbps RJ45 port
	USB	Two USB2.0 interface for mouse and external storage

	Video Output	One HDMI, and one VGA
	Power Input	One DC power supply jack
	Button	One power on/off button, and one reset button
	Alarm in/out	4 channels sensor inputs and 1 channel alarm out
<b>Software Features</b>	Control Method	Mouse/Internet Browser
	Display Switch	1 channel 1080 or 4 channel 960P / 720P or 9 channel VGA display switch
	Record Mode	Manual /Time Scheduled/Alarm Triggered/Motion Detect
	Video Playback	1 channel 1080 or 4 channel 960P / 720P synchronous video playback ,Fast forward / Rewind / Slow Play
	PTZ	Supports Pan/Tilt/Zoom control,Optical Zoom supported
	Camera Search/Management	Search cameras in LAN, add camera, and manage a camera list
	Application support	Remote configuration,video browse,local record,local and remote playback,Remote upgrade
	Disk Management	Set the video coverage strategy, format disk
	Motion Detection	Alarm area and schedule settings
	User Accounts	User account management
	Operating System	Microsoft Windows XP, 7, 8, 8.1, Mac OS
Browser	Microsoft IE8 and above version ,Firefox,Safari	
<b>Physical and Environmental</b>	Power Supply	DC 12V/3.0A
	Dimension(LxWxH)	220 × 209 × 40mm (L x W x H)
	Net Weight (g)	750g
	Operating Temperature	-20°C ~ 55°C (-4°F ~ 131°F)
	Operating Humidity	20% ~ 85% non-condensing
	Storage Temperature	-20°C ~ 60°C (-4°F ~ 140°F)
	Storage Humidity	0% ~ 90% non-condensing

## 5.4 List of Third-party list

### List of Third-party HDD

Brand	Model	Description
Western Digital	WD5000AAKX	500GB 7200RPM 16MB SATA3
	WD10EZEX	1TB 7200RPM 64MB SATA3
	WD10EURX	1TB 7200RPM 64MB SATA3
	WD20EZR	2TB 5400RPM 64MB SATA3
	WD4001FAEX	4TB 7200RPM 64MB SATA3
	WD40EURX	4TB 7200RPM 64MB SATA3
Seagate	ST500DM002	500GB 7200RPM 16MB SATA3
	ST1000DM003	1TB 7200RPM 64MB SATA3
	ST1000VX000	1TB 7200RPM 64MB SATA3
	ST2000VX000	2TB 7200RPM 64MB SATA3
	ST4000DM000	4TB 5900RPM 64M SATA
TOSHIBA	DT01ABA200V	2TB 5700RPM 32MB SATA3
HGST	HUS724020ALA640	2TB 7200RPM 64MB SATA

### List of Third-party Mobile Hard Disk

Brand	Mode	Description
SAMSUNG	M3	500GB, Mobile Hard Disk 5400RPM 8MB Cache USB3.0
	M3	1TB, Mobile Hard Disk 5400RPM 8MB Cache USB3.0
TOSHIBA	HDTB105AK3AA	500GB, Mobile Hard Disk 5400RPM 8MB Cache USB3.0
Western Digital	WDBUZG0010BBK-01	1TB, Mobile Hard Disk 5400RPM USB3.0
	DS11-201312-0043	2TB, Mobile Hard Disk 5400RPM USB3.0
Seagate	STBV4000300	New Seagate Expansion 4TB, Mobile Hard Disk 5400RPM USB3.0

## 5.5 FAQ

### 1. No image displayed on the monitor after starting up normally.

- Verify the device is connected with the monitor via HDMI or VGA cable.
- Verify the connection cable is good.
- Verify Input mode of the monitor is correct.

Please check the input mode of the monitor matches with the output mode of the device (e.g. if the output mode of NVR is HDMI output, then the input mode of monitor must be the HDMI input). And if not, please modify the input mode of monitor.

### 2. No record file found in the NVR local HDD, and prompt “No record file found”.

- Verify the system time setting is correct.

Choose “Menu > Settings > General” in the GUI interface, and verify the time is correct.

- Verify the search condition is correct.

Choose “Menu > Playback” in the GUI interface, and verify the channel and time are correct.

- Verify the HDD status is normal.

Choose “Menu > About > HDD Info” in the GUI interface, view the HDD status.

### 3. Why recording is not performed after motion detection is enabled?

On the “Motion Detection” page, check whether the following are correctly set:

- Check whether the motion detection channel is correct.
- Check whether a trigger time segment is set.
- Check whether a detection area is set.
- Check whether recording is selected.

### 4. Why doesn't the monitor respond when I operate the remote control?

- Check the battery of the remote control (positive and negative poles or battery level).
- Check whether the remote control is aligned with the middle position of the front panel of the NVR.
- Check whether you use the remote control correctly.
- Check whether the remote control is interfered by fluorescent lights around.

### 5. Why can the NVR search the IPC but cannot connect the IPC?

On the “IPC management” page, check whether the following are correctly set:

- Check whether the user name and password for the IPC are correct.
- Check whether the web page port for the IPC is correct.
- Check whether the IPC also supports the protocol selected in the NVR.

### 6. The screen of the display is incomplete.

Confirm the current resolution and check the resolution supported by the display. If the resolution is 1920\*1080, the display needs to support the resolution 1920\*1080.

### 7. Why can't opened web pages on the client be used properly after the NVR server switches to the 1080P mode?

When the NVR server switches to the 1080P mode, some functions can take effect only after the server reboots. In this case, log out of the Web client and log in to it again. In similar cases, for example, changing the IP address and HTTP port of the NVR, you need to log in to the client again.

### 8. Why can't video files be downloaded during video playback or downloaded files cannot be played back properly?

To save consumed resources, the server limits concurrency of video playback and file download. In this case, stop video playback and then download files or play back videos after video files are downloaded.

### 9. Why does the Web client prompt TIME OUT after you enable or disable UPNP in network settings?

In this case, the server restarts some applications. Accordingly, you need to exit the web client and log in to the client again.

### 10. It prompt "Have no right to create directory or file!" after taking snapshot.

When you use Windows7 or Vista, you may be not able to snapshot path because of the security settings of computer.

Please add the NVR as a trusted site to resolve this issue. Open IE browser, Choose "Tools > Internet Options > Security", Select "Trusted sites", then click "Sites", it will pop up the page, as shown in the following figure.

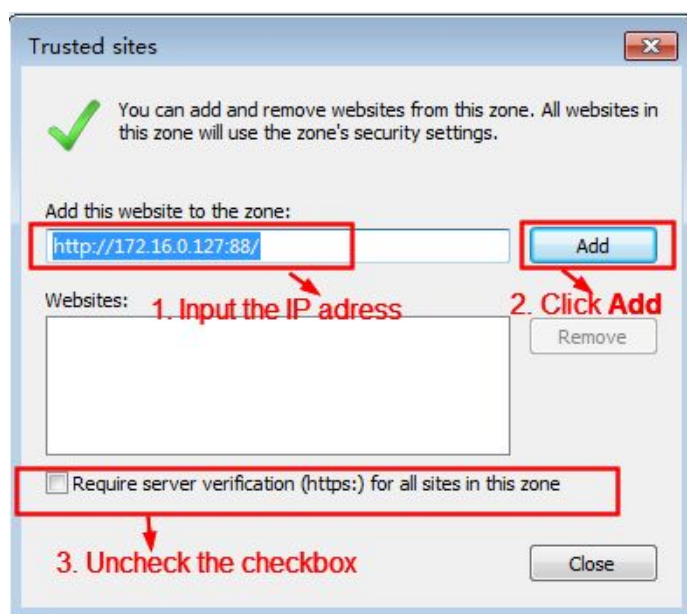

**11. After the adding of the IPC successfully, the video of the corresponding channel has lost in the live view mode.**

Make sure that the IPC display mode is not more than NVR display mode. For example: NVR display mode for the 4 \* 960P, the IPC display mode can not be 1080P.

**12. Why does the Web client prompt the message” Plugins are not found, Click me to download” or “Find a new Plugins, Click me to download” after installing plug-in?**

You need to close the current browser after installing the plug-in, and then open the browser to access the login page.

## 5.6 Glossary

Acronym	Term	Description
DDNS	Dynamic Domain Name Server	Dynamic DNS is a method, protocol, or network service that provides the capability for a networked device, such as a router or computer system using the Internet Protocol Suite, to notify a domain name server to change, in real time (ad-hoc) the active DNS configuration of its configured hostnames, addresses or other information stored in DNS.
DHCP	Dynamic Host Configuration Protocol	DHCP is a network application protocol used by devices (DHCP clients) to obtain configuration information for operation in an Internet Protocol network.
HDD	Hard Disk Drive	A storage medium which stores digitally encoded data on platters with magnetic surfaces.
HTTP	Hypertext Transfer Protocol	A protocol to transfer hypertext request and information between servers and browsers over a network
PPPoE	Point-to-Point Protocol over Ethernet	It is a network protocol for encapsulating Point-to-Point Protocol (PPP) frames inside Ethernet frames. It is used mainly with ADSL services where individual users connect to the ADSL transceiver (modem) over Ethernet and in plain Metro Ethernet networks.

PTZ	Pan, Tilt, Zoom	PTZ cameras are motor driven systems that allow the camera to pan left and right, tilt up and down and zoom in and out.
NTP	Network Time Protocol	A protocol designed to synchronize the clocks of computers over a network.
NVR	Network Video Recorder	A NVR can be a PC-based or embedded system used for centralized management and storage for IP cameras.

## 5.7 CE & FCC

### Electromagnetic Compatibility (EMC)

#### FCC Statement



**This device complies with FCC Rules Part 15. Operation is subject to the following two conditions.**

- This device may not cause harmful interference, and
- This device must accept any interference received, including interference that may cause undesired operation.

This equipment has been tested and found to comply with the limits for a Class B digital device, pursuant to Part 15 of the FCC Rules. These limits are designed to provide reasonable protection against harmful interference when the equipment is operated in a commercial environment. This equipment generates, uses, and can radiate radio frequency energy and, if not installed and used in accordance with the installation manual, may cause harmful interference to radio communications. Operation of this equipment in a residential area is like to cause harmful interference, in which case the user will be required to correct the interference at his own expense.

#### FCC Caution

Any changes or modification not expressly approved by the party responsible for compliance could void the user's authority to operate this equipment.

#### CE Mark Warning





This is a Class B product. In a domestic environment, this product may cause radio interference, in which case the user may be required to take adequate measures.

## 5.8 WARRANTY

ShenZhen FOSCAM Intelligent Technology Limited.("FOSCAM") values your business and always attempts to provide you the very best of service.

No limited hardware warranty is provided by FOSCAM unless your FOSCAM product ("product") was purchased from an authorized distributor or authorized reseller. Distributors may sell products to resellers who then sell products to end users. No warranty service is provided unless the product is returned to an authorized return center in the region where the product was first shipped by FOSCAM or to the point-of-purchase, which may have regional specific warranty implications.

**If you purchase your FOSCAM product from online store, please contact the point-of-purchase and ask for return/replacement/repair service.**

### Hardware Warranty Information

FOSCAM provide 2-year limited warranty for naked product and 6-month limited warranty for accessories.

### Limited Hardware Warranty

- FOSCAM products are warranted to be free from manufacturing defects in materials and workmanship starting from the shipping date of FOSCAM.

This limited hardware warranty does not cover:

- Software, including the software added to the products through our factory-integration system, software that included in the CD,etc.
- Usage that is not in accordance with product instructions.
- Failure to follow the product instructions.
- **Abuse firmware upgrade without the authorized technician's guidance.**
- **Normal wear and tear.**

### Return Procedures

- Please read FOSCAM warranty policy & policy of your reseller first before sending items back to point-of-purchase.
- Customer must first contact point-of-purchase to obtain a Return Merchandise Authorization (RMA) number before returning the product. If the product you received is suspected to be defective and the product warranty has not expired, The RMA number will allow your reseller to track your return much easier and help them expedite processing your request.
- After receiving your RMA case number, pack the item(s) very well with the original box and all the original accessories included such as power adapters, brackets, cables, manuals, and driver CD disks.
- Write your RMA number and the return reason (the problem of the product) on the warranty card along with the complete package to send them back.

### **Replacement Services**

- **If customers ask for replacement service, please contact point-of-purchase and follow their policy.**
- Our technicians will inspect all items returned for replacement requests. If the returned product is found in working order, we will return the same item received. However customers shall be responsible for all shipping & handling charges incurred for getting the units back to customers.
- If returned products are found defective, we will replace the product and assume the shipping cost for sending back the replacement unit to customers.
- If for any reason, we are unable to provide a replacement of the original returned item(s). You will have a choice for a “Substitute” item at the same equal value.
- We do not provide exchange and replacement due to normal hardware upgrade according the market after 14 days after the product is delivered.
- Our technicians will test the product before send out the replacement, any other demand for more than two times replacement for the same product during replacement limit will be rejected.
- **Replaced products are warranted from the balance of the former warranty period.**

### **Warranty Forfeiture**

- Warranty is void if purchase from unauthorized distributor or reseller.
- Warranty is void if trade-mark, serial tags, product stickers have been removed, altered or tampered with.
- Warranty is void for mishandling, improper use, or defacing the product.
- **Abuse firmware upgrade without the authorized technician’s guidance.**
- Warranty is void for physical damage, altered, either internally or externally, improper or inadequate

packaging when returned for RMA purposes.

- Warranty is void if damage has resulted from accident, dismantle, abuse, or service or modification by someone other than the appointed vendor, source, fission or the spare part has been over the period of warranty.
- Warranty is void if product is damaged due to improper working environment or operation. (For example, improper temperature, humidity, unusual physical or electrical stress or interference, failure or fluctuation of electrical power, static electricity, using wrong power adapter, etc.)
- Warranty is void if damaged by the use of parts not manufactured or sold by FOSCAM.
- Damage caused by improper installation of third-party products.
- Warranty is void if damaged for irresistible cause, such as earthquake, fire, lightning, flood, etc.
- Product beyond limited warranty.

### **Shipping Fee**

- If products are defective or damaged under normal use or operation in the replacement limit, distributors or resellers are responsible for the shipping cost the product back to customers, customers should assume the shipping cost send the product to the point-of-purchase.
- During replacement limit, if customers ask for replacement due to the product does not fit for customer's personal expectation, customers should responsible for both shipping fee.
- Customers shall be responsible for both shipping fee if their product beyond the replacement limit but still in warranty limit.

### **Repair Service Out Of Warranty**

- FOSCAM provide extra repair service for product that out of warranty, it is chargeable. The total fee contains device cost and service fee. Device cost (including accessories) is the standard uniform price provide by FOSCAM.
- Different region may have different service fee, please contact the point-of-purchase to confirm that before you ask for this service.
- Our technicians will quote the total price after detect the product, If customers refused to repair after the quotation, customers need pay for the test fee, \$3.5/hour. If agree with the quotation, test will be free.
- Repaired product out of warranty will obtains 3-month warranty from the date of the product back to customers.

### **Limitation of Liability**

- FOSCAM is not responsible for other extra warranty or commitment promised by resellers, if your reseller promised some extra commitment or warranty; please ask for written documents to protect your rights and interests.
- FOSCAM does not offer refunds under any circumstances. Please contact the point-of-purchase and follow their refund/return policy.
- FOSCAM shall not be liable under any circumstances for any consequential, incidental, special or exemplary damages arising out of or in any connection with this agreement or the products, including but not limited to lost profits, or any claim based on indemnity or contribution, or the failure of any limited or exclusive remedy to achieve its essential purpose or otherwise. Purchaser's exclusive remedy, as against FOSCAM, shall be the repair or replacement of defective parts. If FOSCAM lists a product on its website specification in error or that is no longer available for any reason, FOSCAM reserves the right to explain it without incurring any liability.

**All rights reserved. FOSCAM and the FOSCAM logo are trademarks of ShenZhen FOSCAM Intelligent Technology Limited., registered in the U.S. and other countries.**

## 5.9 Obtaining Technical Support

While we hope your experience with the NVR is enjoyable and easy to use, you may experience some issues or have questions that this User's Guide has not answered.

If you have problem with FOSCAM device, please first contact FOSCAM reseller for solving the problems. If our reseller cannot provide service, please contact our service department:

[tech@foscam.com](mailto:tech@foscam.com)